

# Bolt-A-Plate®



[www.ail.ca](http://www.ail.ca)



Atlantic Industries Limited  
**We Support You.**



All's Bolt-A-Plate product is used to form the outer rings of wind turbine bases. Helical Corrugated Steel Pipe is used for the inner rings of the bases.

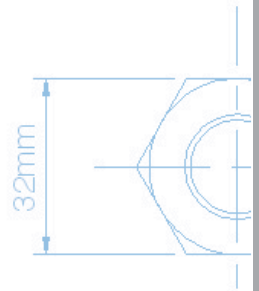

# Our Commitment

**Atlantic Industries Limited (AIL) has built a solid reputation by providing professional support and innovative, high quality corrugated metal products around the world.**

Innovative ideas, quality production facilities, leading-edge project management and dependable service make AIL a leader in engineered solutions.

You can count on our solutions to help you overcome your biggest challenges. We combine strategic problem-solving and engineering expertise to give you the advice and support you need.

We welcome the opportunity to discuss your next project. Please contact your local AIL technical representative for assistance.

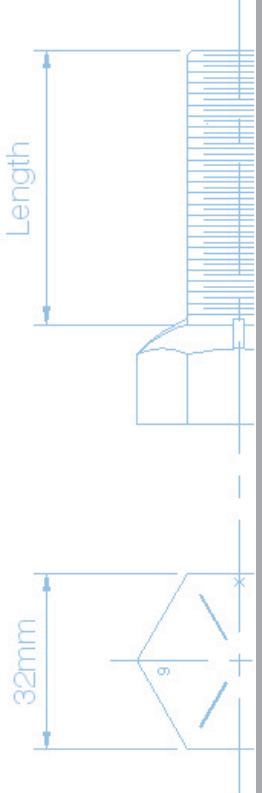

# Bolt-A-Plate®

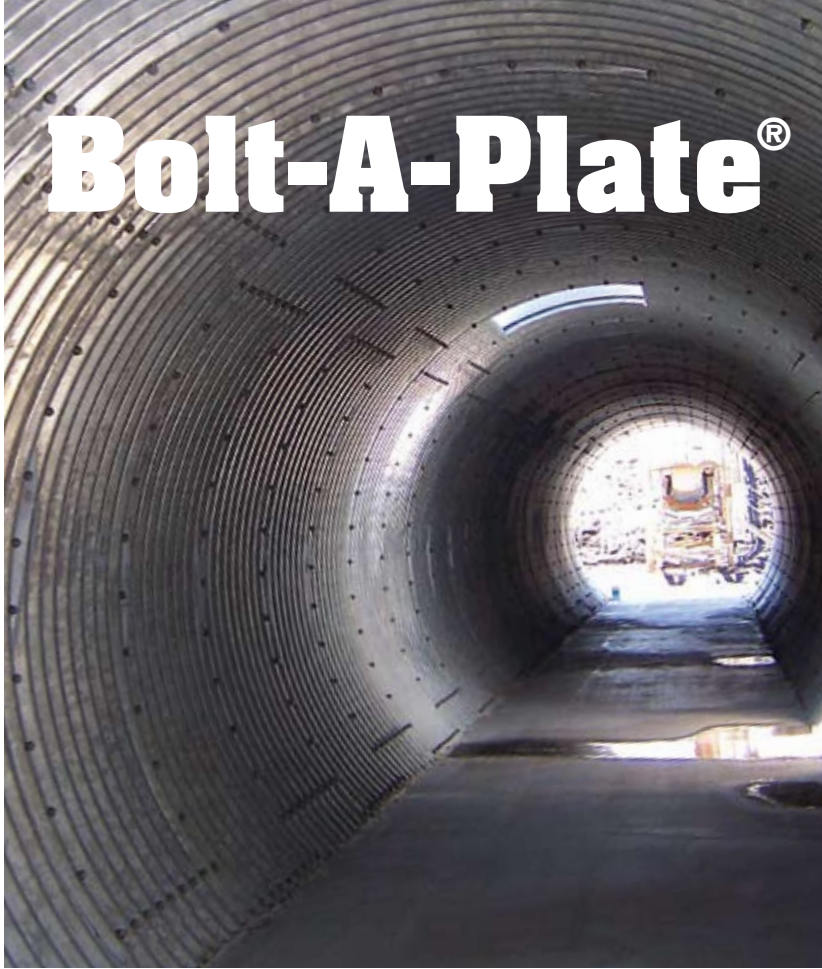

Bolt-A-Plate® is ideal for rolling countryside, farmland and other rural environments. It maintains natural streambeds and helps counter erosion. Bolt-A-Plate® structures are effectively utilized as strong and economical alternatives to elaborate bridge replacement by municipal and provincial governments.



**Strong**  
**Economical**  
**Lightweight**

Bolt-A-Plate® is ideal for:

- Underpasses
- Culverts
- Stream enclosures
- Fishways
- Bridge replacement
- Utilidors



**High Profile** arches are engineered to maintain a natural waterway and allow for an abrasive bedload. Additionally, these arches are ideal for projects that include large end areas or large spans. The high profile arch is also used for highway grade separations.

Clearance Box sizes are available from your local AIL representative.

**Standard and Low Profile** arches anchored on footings are ideal for installations where there is limited headroom and low height of cover restrictions. They are especially useful in sites where it is desirable to maintain natural stream beds and are widely used for stream enclosures, culverts and storm sewers.

**Pear Shape** is generally used for railway tunnels and underpasses. With proper end treatment, Bolt-A-Plate® provides access and protects the environment from erosion problems.

**Round Pipe** is the most common and versatile of the Bolt-A-Plate® shapes. This shape is used primarily for culverts, sewers and sub-drains, but is also appropriate for storage bins, tunnels and bridges.

**Pipe-Arch** is ideal for bridges and underpasses with limited overhead clearance. Pipe-arch's unique shape provides hydraulic advantages at low flow rates for culverts and sewers.

**Elliptical** shapes are commonly used for underpasses and service tunnels. The **horizontal** ellipse is better suited for multi-lane, vehicular underpasses, while the **vertical** ellipse shape is more appropriate for single lane vehicular and railway underpasses.

Bolt-A-Plate® provides overhead protection from falling rock and mudslides and blends in with the structures' natural surroundings.

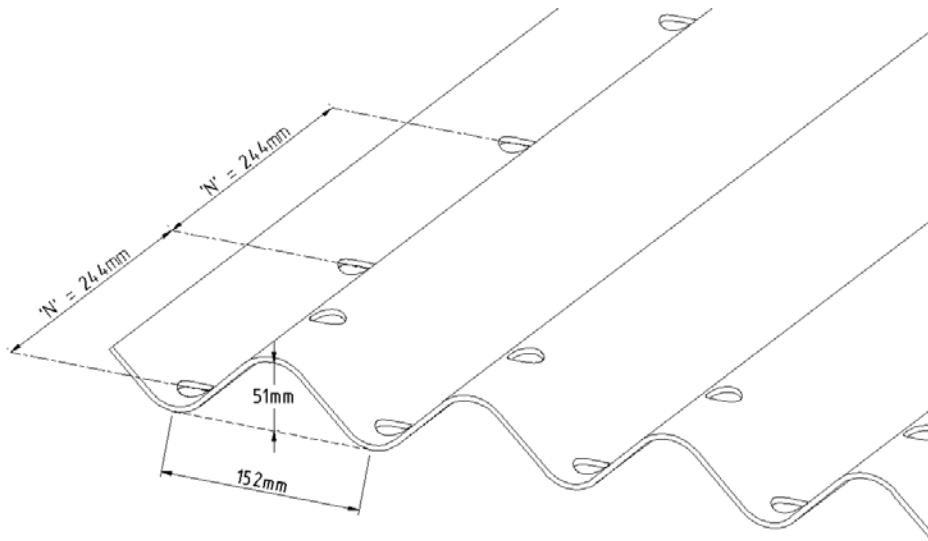

### Corrugation Profile: 152 mm x 51 mm

Corrugation Radius (CR): 28.58 mm

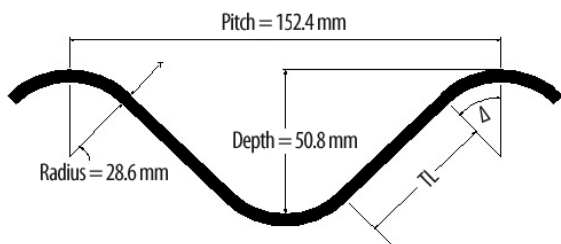

Specified (mm)	Wall Thickness		Tangent		Moment of Inertia(I) (mm <sup>4</sup> /mm)	Section Modulus(S) (mm <sup>3</sup> /mm)	Radius of Gyration(r) (mm)
	Design(T) (mm)	Area(A) (mm <sup>2</sup> /mm)	Length(TL) (mm)	Angle(A) (degrees)			
3.0	2.84	3.522	47.876	44.531	1057.25	39.42	17.326
4.0	3.89	4.828	46.748	44.899	1457.56	53.30	17.375
5.0	4.95	6.149	45.582	45.286	1867.12	66.98	17.425
6.0	6.00	7.461	44.396	45.686	2278.31	80.22	17.475
7.0	7.00	8.712	43.237	46.083	2675.11	92.56	17.523

## HIGH PROFILE ARCH

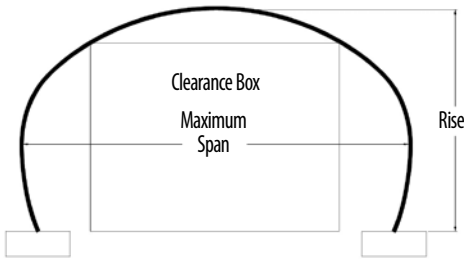

ALL DIMENSIONS ARE TO INSIDE CREST OF STEEL  
 MINIMUM COVER IS FROM NEUTRAL AXIS OF STEEL  
 CL Vehicle Minimum Cover  
 CHBDC for Span > 3000 mm  
 ASTM A796 (AISI) for Span < 3000 mm

No.	Max. Span (mm)	Bottom Span (mm)	Total Rise (mm)	End Area (m <sup>2</sup> )	Minimum Cover (mm)		No.	Max. Span (mm)	Bottom Span (mm)	Total Rise (mm)	End Area (m <sup>2</sup> )	Minimum Cover (mm)	
					CL Vehicle	E-80						CL Vehicle	E-80
23HA6-6	6300	5740	3680	20.34	1262	1270	33HA8-8	8966	8255	5004	38.16	1822	1822
21HA5-4	6121	5944	2769	14.07	1296	1296	36HA6-9	9220	8420	4920	40.28	2008	2008
25HA7-8	6960	6045	4445	26.41	1378	1402	37HA8-12	9855	8509	6071	51.29	2044	2044
25HA5-6	6550	6050	3560	20.46	1384	1384	36HA6-8	9906	8585	4699	36.94	2227	2227
26HA6-8	6985	6096	4267	25.48	1433	1433	36HA8-10	9627	8636	5588	46.05	1986	1986
26HA5-6	6780	6270	3610	21.36	1440	1440	37HA6-9	9450	8670	4970	41.53	2064	2064
27HA5-6	7010	6530	3660	22.28	1496	1496	37HA7-10	9652	8687	5410	44.72	2050	2050
27HA7-8	7417	6553	4521	28.66	1489	1494	38HA6-10	9680	8740	5260	45.25	2121	2121
29HA5-8	7468	6680	4191	26.67	1614	1614	38HA8-12	10084	8763	6121	52.86	2101	2101
28HA5-6	7240	6760	3680	23.21	1562	1562	37HA6-8	9449	8839	4750	38.12	2060	2060
30HA5-6	7670	7230	3740	25.09	1672	1672	39HA6-10	9910	8990	5280	46.58	2189	2189
30HA6-9	7870	6920	4655	32.98	1660	1660	39HA8-12	10312	9017	6172	54.47	2159	2159
29HA7-8	7849	7061	4623	30.94	1595	1595	41HA7-12	10541	9322	6045	54.67	2277	2277
30HA5-7	7671	7087	4013	26.16	1665	1665	41HA8-13	10744	9322	6477	59.75	2268	2268
31HA6-9	8100	7190	4650	34.17	1719	1719	41HA6-10	10363	9500	5385	47.53	2298	2298
30HA7-8	8077	7315	4648	32.13	1652	1652	41HA6-12	10360	9140	5830	54.58	2303	2303
31HA5-7	7899	7341	4039	27.19	1714	1714	42HA7-12	10770	9576	6096	56.23	2337	2337
33HA6-10	8560	7500	5020	38.74	1834	1834	41HA11-13	11354	9906	7137	69.21	2259	2281
31HA7-8	8306	7569	4699	33.32	1710	1710	41HA11-12	11350	10130	6910	69.09	2258	2280
34HA5-9	8590	7750	4630	35.51	1906	1906	42HA11-13	11582	10185	7163	71.06	2315	2327
33HA5-7	8357	7823	4140	29.29	1848	1848	42HA6-10	10570	9730	5440	50.65	2357	2357
34HA5-8	8585	7899	4394	32.20	1903	1903	42HA6-12	10590	9390	5870	56.07	2364	2364
34HA8-10	9169	8153	5512	43.21	1871	1871	42HA11-12	11580	10390	6930	70.85	2318	2326

## LOW PROFILE ARCH

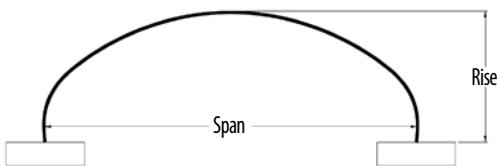

ALL DIMENSIONS ARE TO INSIDE CREST OF STEEL  
 MINIMUM COVER IS FROM NEUTRAL AXIS OF STEEL  
 CL Vehicle Minimum Cover  
 CHBDC for Span > 3000 mm  
 ASTM A796 (AISI) for Span < 3000 mm

No.	Max. Span (mm)	Bottom Span (mm)	Total Rise (m <sup>2</sup> )	Minimum Cover (mm)		No.	Max. Span (mm)	Bottom Span (mm)	Total Rise (m <sup>2</sup> )	Minimum Cover (mm)	
				CL Vehicle	E-80					CL Vehicle	E-80
23 LA 6	6120	6050	2290	1254	1254	36 LA 7	9220	9170	3020	1986	1986
23 LA 5	5920	5820	2080	1248	1248	36 LA 9	9420	9270	3480	1946	1946
25 LA 6	6550	6500	2360	1370	1370	36 LA 10	9630	9500	3680	1952	1952
26 LA 6	6780	6730	2410	1424	1424	37 LA 7	9450	9400	3070	2045	2045
27 LA 6	7010	6930	2440	1470	1470	37 LA 10	9860	9730	3730	2007	2007
28 LA 6	7240	7160	2490	1535	1535	38 LA 7	9680	9630	3120	2104	2104
29 LA 6	7470	7390	2540	1591	1591	38 LA 10	10080	9930	3780	2053	2053
30 LA 6	7670	7620	2570	1656	1656	39 LA 9	10110	9960	3610	2120	2120
31 LA 6	7900	7850	2620	1713	1713	39 LA 11	10490	10390	4040	2116	2116
31 LA 9	8310	8150	3280	1663	1663	41 LA 9	10540	10410	3680	2238	2238
33 LA 7	8560	8510	2920	1817	1817	41 LA 14	11560	11460	4780	2235	2302
33 LA 9	8760	8610	3350	1781	1781	42 LA 9	10770	10570	3730	2271	2271
34 LA 7	8790	8740	2950	1876	1876	42 LA 14	11790	11680	4800	2285	2346

## STANDARD ARCH

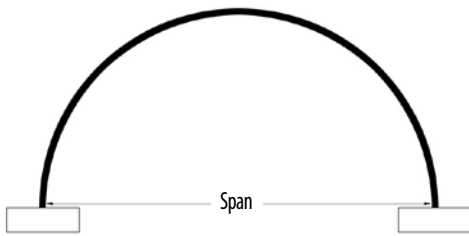

ALL DIMENSIONS ARE TO INSIDE CREST OF STEEL  
 MINIMUM COVER IS FROM NEUTRAL AXIS OF STEEL  
 CL Vehicle Minimum Cover  
 CHBDC for Span > 3000 mm  
 ASTM A796 (AISI) for Span < 3000 mm

No.	Span (mm)	Rise (mm)	End Area (m <sup>2</sup> )	Min. Cover (mm)	
				CL Vehicle	E-80
10 A	1520	810	0.98	300	314
11A	1830	840	1.16	300	382
12 A1	1830	970	1.39	300	374
12 A2	2130	860	1.39	300	446
14 A1	2130	1120	1.86	300	438
14 A2	2440	1020	1.86	314	502
16 A1	2440	1270	2.42	311	498
16 A2	2740	1180	2.46	356	570
18 A	2740	1440	3.07	349	558
18 A2	3050	1350	3.16	600	600
20 A	3050	1600	3.81	600	600
19 A	3350	1360	3.44	600	600
22 A	3350	1750	4.65	600	600
21 A	3660	1520	4.18	625	625
24 A	3660	1910	5.48	619	619
23 A	3960	1680	5.02	679	679

No.	Span (mm)	Rise (mm)	End Area (m <sup>2</sup> )	Min. Cover (mm)	
				CL Vehicle	E-80
26 A1	3960	2060	6.50	669	669
25 A	4270	1840	5.95	729	729
28 A1	4270	2210	7.43	719	719
26 A2	4570	1870	6.41	789	789
30 A1	4570	2360	8.55	772	772
28 A2	4880	2030	7.43	835	835
32 A	4880	2520	9.75	822	822
30 A2	5180	2180	8.55	882	882
34 A	5180	2690	11.06	872	872
31 A	5490	2210	9.01	949	949
35 A1	5490	2720	11.71	922	922
33 A	5790	2360	10.22	992	992
37 A	5790	2880	13.01	975	975
35 A2	6100	2530	11.52	1042	1042
39 A	6100	3050	14.59	1025	1025

## PEAR SHAPED UNDERPASS

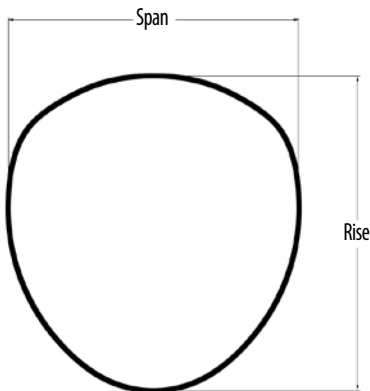

Structure No.	Max. Span (mm)	Bottom Rise (mm)	Total Rise (mm)	End Area (m <sup>2</sup> )
25 PS 5-24-15	7210	4550	7820	44.69
27 PS 5-25-18	7570	5100	8430	50.54
30 PS 6-26-16	8360	5510	8230	53.70
28 PS 5-30-12	8100	5460	8610	54.91
27 PS 8-22-25	8560	5130	8480	57.97
27 PS 5-24-18	7320	4880	8530	48.84

Notes: Structure No. 25 PS 5-24-15 = 25 N Top, 5N corners, 24N Sides, 15 N Bottom, Where N = 3 Pi, & PS = Pear shape  
 Dimensions are to inside crest

## ROUND

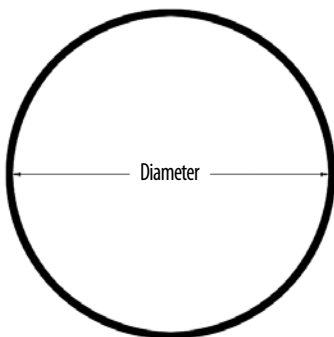

ALL DIMENSIONS ARE TO INSIDE CREST OF STEEL  
 MINIMUM COVER IS FROM NEUTRAL AXIS OF STEEL  
 CL Vehicle Minimum Cover  
 CHBDC for Span > 3000 mm  
 ASTM A796 (AISI) for Span < 3000 mm

No.	Span (mm)	End Area (m <sup>2</sup> )	Min. Cover (mm)	
			CL Vehicle	E-80
20 R	1500	1.77	300	310
22 R	1660	2.16	300	342
24 R	1810	2.57	300	372
26 R	1970	3.05	300	404
28 R	2120	3.53	300	434
30 R	2280	4.08	300	466
32 R	2430	4.64	310	496
34 R	2590	5.27	330	528
36 R	2740	5.89	349	558
40 R	3050	7.30	600	620
44 R	3360	8.86	600	682
48 R	3670	10.57	620	744
52 R	3990	12.50	674	808

No.	Span (mm)	End Area (m <sup>2</sup> )	Min. Cover (mm)	
			CL Vehicle	E-80
56 R	4300	14.49	725	870
60 R	4610	16.66	777	932
64 R	4920	18.99	829	994
68 R	5230	21.46	880	1056
72 R	5540	24.08	932	1118
76 R	5850	26.86	984	1180
80 R	6160	29.79	1035	1242
84 R	6470	32.87	1087	1304
88 R	6780	36.10	1139	1366
92 R	7090	39.48	1190	1428
96 R	7400	43.01	1242	1490
100 R	7710	46.70	1294	1552
104 R	8020	50.53	1345	1614

## PIPE-ARCH

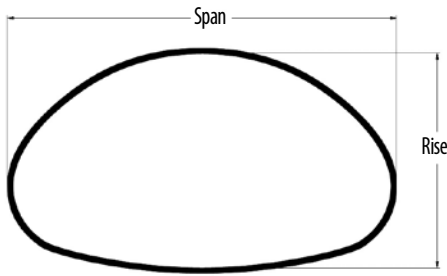

ALL DIMENSIONS ARE TO INSIDE CREST OF STEEL  
 MINIMUM COVER IS FROM NEUTRAL AXIS OF STEEL  
 CL Vehicle Minimum Cover  
 CHBDC for Span > 3000 mm  
 ASTM A796 (AISI) for Span < 3000 mm

No.	Span (mm)	Rise (mm)	End Area (m <sup>2</sup> )	Min. Cover (mm)	
				CL Vehicle	E-80
11 PA 6-5	1854	1397	2.04	300	381
12 PA 6-5	1930	1448	2.23	300	396
12 PA 6-6	2057	1499	2.42	300	422
9 PA 10-5	2060	1520	2.49	300	422
13 PA 6-6	2134	1549	2.60	300	437
14 PA 6-6	2210	1600	2.88	300	452
11 PA 10-5	2240	1630	2.90	300	458
14 PA 6-7	2337	1651	3.07	300	478
15 PA 6-7	2413	1702	3.25	308	493
12 PA 10-6	2440	1750	3.36	311	498
16 PA 6-7	2489	1753	3.53	318	508
14 PA 10-6	2590	1880	3.87	330	528
16 PA 6-8	2616	1803	3.72	333	533
16 PA 10-6	2690	2080	4.49	343	548
17 PA 6-8	2692	1854	3.99	343	549
17 PA 6-9	2845	1905	4.27	362	579
18 PA 6-9	2896	1956	4.55	368	589
19 PA 6-9	2972	2007	4.83	378	605
15 PA 10-9	3100	1980	4.83	600	630
19 PA 6-10	3124	2057	5.11	600	635
19 PA 6-11	3251	2108	5.39	600	660
20 PA 6-11	3327	2159	5.67	600	676
15 PA 10-11	3400	2010	5.28	684	690
20 PA 6-12	3480	2210	5.95	630	706
21 PA 6-12	3531	2261	6.22	628	716
22 PA 6-12	3607	2311	6.60	633	732
18 PA 10-12	3730	2290	6.61	722	756
22 PA 6-13	3759	2362	6.87	674	762
23 PA 6-13	3810	2413	7.25	672	772
24 PA 6-13	3861	2464	7.53	671	782
23 PA 10-11	3890	2690	8.29	682	788
25 PA 6-13	3912	2540	7.90	665	793
24 PA 10-12	4039	2845	9.01	709	818
25 PA 6-14	4089	2565	8.27	716	828
25 PA 10-12	4115	2896	9.48	715	833

No.	Span (mm)	Rise (mm)	End Area (m <sup>2</sup> )	Min. Cover (mm)	
				CL Vehicle	E-80
25 PA 6-15	4242	2616	8.64	759	859
25 PA 10-13	4267	2946	9.75	754	864
26 PA 6-15	4293	2667	9.01	756	869
26 PA 10-13	4318	2997	10.13	754	874
27 PA 6-15	4343	2718	9.38	754	879
24 PA 10-14	4370	2870	9.76	798	884
27 PA 10-13	4394	3048	10.59	760	889
27 PA 6-16	4521	2769	9.75	803	914
27 PA 10-14	4547	3099	10.96	799	920
27 PA 6-17	4674	2819	10.13	847	945
27 PA 10-15	4720	3070	11.38	844	954
28 PA 6-17	4724	2870	10.50	843	955
28 PA 10-15	4750	3200	11.80	722	960
29 PA 6-17	4775	2921	10.96	840	965
30 PA 6-17	4826	2997	11.33	832	975
29 PA 10-15	4826	3251	12.26	844	975
29 PA 10-16	4953	3302	12.73	878	1001
30 PA 6-18	5004	3023	11.71	886	1011
30 PA 10-16	5050	3330	13.24	887	1020
31 PA 6-18	5055	3073	12.17	883	1021
30 PA 10-17	5182	3404	13.56	924	1047
31 PA 10-17	5232	3454	14.03	923	1057
32 PA 10-17	5309	3505	14.59	928	1072
32 PA 10-18	5490	3530	15.10	975	1108
33 PA 10-18	5512	3607	15.51	967	1113
33 PA 10-19	5664	3658	15.98	1009	1143
34 PA 10-19	5715	3708	16.44	1007	1153
34 PA 10-20	5890	3710	17.07	1056	1188
35 PA 10-20	5944	3810	17.47	1053	1199
36 PA 10-20	5994	3861	18.02	1051	1209
37 PA 10-20	6071	3912	18.58	1056	1224
37 PA 10-21	6250	3910	19.18	1106	1260
38 PA 10-21	6274	4013	19.60	1095	1265
31 PA 22-21	7040	4060	22.48	1422	1418
33 PA 22-24	7620	4240	25.27	1571	1534

## VERTICAL ELIPSE

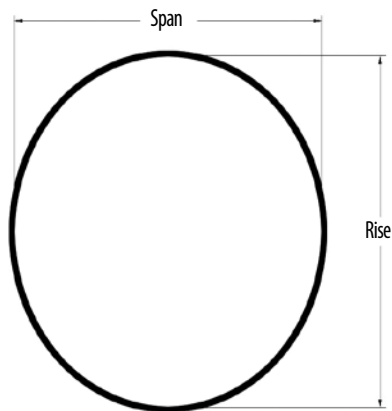

No.	Span (mm)	Rise (mm)	End Area (m <sup>2</sup> )	Min. Cover (mm)	
				CL Vehicle	E-80
10 VE 6	2310	2570	4.63	300	472
11 VE 6	2460	2740	5.23	314	502
9 VE 9	2620	2900	5.89	334	534
14 VE 6	2920	3230	7.29	371	594
16 VE 6	3200	3560	8.86	600	650
18 VE 6	3580	3890	10.87	600	726
17 VE 9	3810	4220	12.43	612	772
19 VE 9	4140	4570	14.43	665	838

No.	Span (mm)	Rise (mm)	End Area (m <sup>2</sup> )	Min. Cover (mm)	
				CL Vehicle	E-80
12 VE 18	4340	4830	16.58	694	878
14 VE 18	4650	5160	18.88	744	940
14 VE 20	4950	5460	21.35	794	1000
18 VE 18	5260	5820	23.97	842	1062
18 VE 20	5540	6120	26.73	887	1118
19 VE 21	5840	6450	29.65	935	1178
21 VE 21	6120	6780	32.72	978	1234

ALL DIMENSIONS ARE TO INSIDE CREST OF STEEL  
 MINIMUM COVER IS FROM NEUTRAL AXIS OF STEEL  
 CL Vehicle Minimum Cover  
 CHBDC for Span > 3000 mm  
 ASTM A796 (AISI) for Span < 3000 mm



## HORIZONTAL ELLIPSE

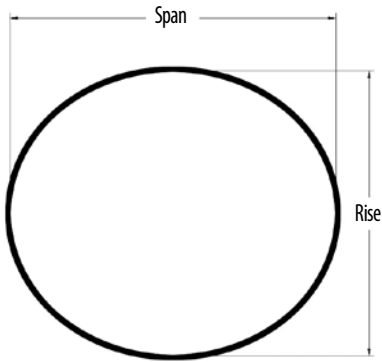

ALL DIMENSIONS ARE TO INSIDE CREST OF STEEL  
 MINIMUM COVER IS FROM NEUTRAL AXIS OF STEEL  
 CL Vehicle Minimum Cover  
 CHBDC for Span > 3000 mm  
 ASTM A796 (AISI) for Span < 3000 mm

No.	Span (mm)	Rise (mm)	End Area (m <sup>2</sup> )	Min. Cover (mm)	
				CL Vehicle	E-80
15 HE 15	1570	1430	1.77	300	324
10 HE 10	1630	1350	1.74	300	336
18 HE 15	1800	1510	2.14	300	370
12 HE 12	2130	1420	2.41	300	436
18 HE 10	2540	1630	3.24	324	518
18 HE 12	2790	1630	3.57	355	568
22 HE 10	2900	1930	4.36	369	590
24 HE 12	3200	2260	5.64	600	650
30 HE 10	3680	2440	6.85	622	746
28 HE 12	3760	2260	6.62	635	762
42 HE 27	3990	3020	9.48	674	808
45 HE 27	4220	3100	10.22	712	854
30 HE 18	4420	2790	9.78	745	894
51 HE 27	4660	3260	11.89	785	942
51 HE 30	4760	3480	12.91	802	962
36 HE 18	4826	3429	12.86	813	975
51 HE 33	4860	3690	14.03	819	982
36 HE 22	5283	3531	14.59	889	1067
60 HE 27	5340	3510	14.49	899	1078
63 HE 27	5560	3590	15.42	935	1122
36 HE 28	5715	3988	18.08	961	1153
66 HE 27	5790	3670	16.44	974	1168
66 HE 30	5890	3890	17.74	990	1188
46 HE 20	6120	3960	18.77	1029	1234
48 HE 18	6230	3840	18.40	1047	1256
72 HE 30	6340	4050	19.79	1065	1278
50 HE 18	6460	3910	19.42	1085	1302
52 HE 18	6680	3990	20.49	1122	1346
54 HE 20	7010	4290	23.15	1177	1412

No.	Span (mm)	Rise (mm)	End Area (m <sup>2</sup> )	Min. Cover (mm)	
				CL Vehicle	E-80
81 HE 42	7420	5160	29.83	1245	1494
58 HE 20	7470	4470	25.49	1254	1504
90 HE 30	7670	4550	26.76	1287	1544
58 HE 30	7950	5540	34.25	1334	1600
93 HE 33	8000	4830	29.76	1342	1610
96 HE 33	8230	4930	31.26	1380	1656
60 HE 32	8280	5820	37.59	1389	1666
93 HE 48	8510	5920	39.24	1427	1712
66 HE 24	8560	5210	34.28	1435	1722
99 HE 48	8790	5310	35.86	1474	1768
66 HE 32	8970	6070	42.23	1504	1804
102 HE 48	9170	6170	44.07	1537	1844
72 HE 24	9220	5460	38.55	1545	1854
105 HE 51	9500	6450	47.64	1592	1910
108 HE 54	9830	6760	51.8	1647	1976
111 HE 54	10060	6830	53.32	1685	2022
78 HE 28	10110	6120	47.57	1694	2032
114 HE 57	10390	7110	57.26	1740	2088
123 HE 42	10540	6300	50.96	1765	2118
82 HE 30	10640	6500	53.29	1782	2138
117 HE 60	10690	7420	61.79	1790	2148
117 HE 66	10900	7850	66.79	1825	2190
84 HE 32	10970	6810	57.51	1837	2204
82 HE 42	11250	7800	68.25	1884	2260
123 HE 45	11330	6760	58.69	1897	2276
84 HE 44	11580	8100	72.93	1939	2326
84 HE 48	11790	8510	78.31	1974	2368
129 HE 78	12190	9020	86.12	2040	2448

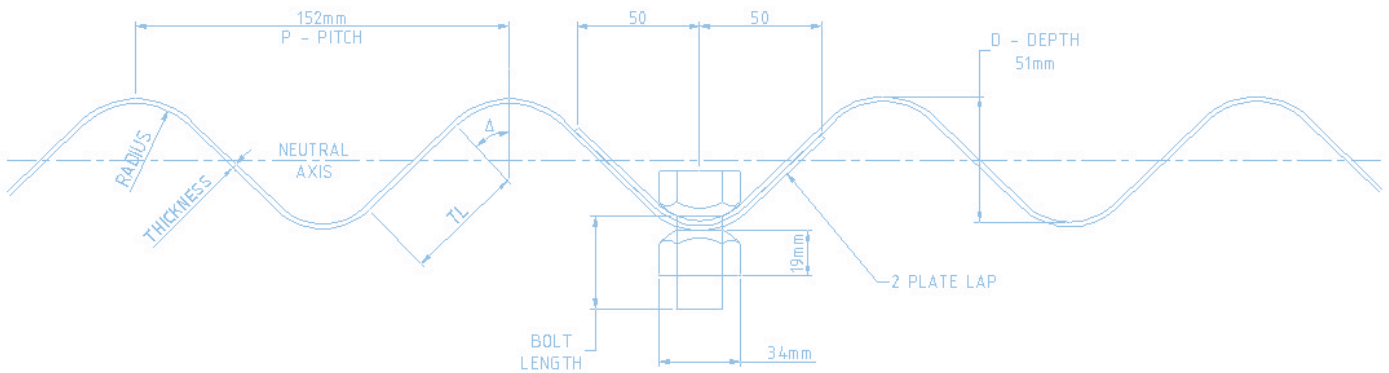



# Bolt-A-Plate® Design and Installation

Bolt-A-Plate® corrugated steel pipe is rapidly becoming the product of choice for high strength, economical bridge and underpass construction. Our engineers are on call to provide complete project assistance and product support from start to finish.

## STRUCTURAL DESIGN

The combination of structural steel and surrounding soil allows Bolt-A-Plate® to support extremely heavy loads. Standard designs are developed in accordance with the Canadian edition of The Handbook of Steel Drainage and Highway Construction Products. However, design assistance and recommendations can be specified to your project. Contact your local AIL sales representative for assistance.

Site preparation should provide a solid base for the structure. It should be good quality material, free from rocks, roots, debris, and organic material. Pre-shaping of the site will allow for different configurations, speed up backfill operations and encourage increased backfill contact. AIL gladly offers technical assistance on foundation investigation and site preparation for varying site conditions.

## SITE INVESTIGATION AND PREPARATION

A thorough site investigation should be conducted before installing a Bolt-A-Plate® structure. If footings are to be used, the foundation will have to be capable of supporting vertical and horizontal loads developed by the structure. The aim is to design a structurally sound foundation that will allow the structure to develop full interaction between soil and steel culvert.

## ASSEMBLY

AIL Bolt-A-Plate® structures may be delivered fully assembled, or may arrive at the site ready for assembly. Every Bolt-A-Plate® structure comes complete with a detailed plan and installation instructions. Experienced supervision will ensure correct, efficient assembly. Upon request, AIL can provide on-site supervision for installation of any structure it supplies.



## PRODUCTS AND SERVICES

- Bolt-A-Plate®
- Corrugated Steel Pipe
- Corrugated Steel Pipe Arch
- Corrugated Aluminum Pipe
- Corrugated Aluminum Arch
- Super•Cor® Structures
- Guiderail Systems
- Bolt-A-Bin®
- Hi-Flo Pipe
- Galvanized Spiral Duct
- Window Wells
- Construction Services
- General Fabrication
- Hot Dip Galvanizing
- Geotextiles
- Erosion Control Products
- Water Control Gates
- Gabion Baskets
- Dur•A•Span® Aluminum Structures
- Aluminized Type II
- MSE Retaining Walls
- Atlantic Precast Walls



Atlantic Industries Limited  
**We Support You.**

### OFFICE LOCATIONS

#### Head Office:

Dorchester, NB  
Canada  
Phone: (506) 379-9212  
Fax: (506) 379-1097

#### Western Canada:

Calgary, AB  
Edmonton, AB  
Westlock, AB  
Armstrong, BC  
Vancouver, BC  
Prince George, BC

#### Eastern Canada:

Dorchester, NB  
Deer Lake, NL  
St. John's, NL  
Louiseville, PQ  
Montréal, PQ

#### Central Canada:

Ayr, ON  
Toronto, ON  
London, ON  
Ottawa, ON  
Thunder Bay, ON

#### United States:

Florida  
Colorado  
Utah  
Georgia

The AIL group of companies:



Atlantic Industries Limited



BIGR  
BRIDGE  
SYSTEMS



VISTAWALL  
SYSTEMS



INTERNATIONAL

FOR ASSISTANCE IN PRICING, ORDERING, OR UNUSUAL INSTALLATIONS,  
CALL TOLL FREE IN NORTH AMERICA: 1 877-AIL-PIPE (1 877-245-7473)

[WWW.AIL.CA](http://WWW.AIL.CA)

