

Buried Metal Bridges & Tunnels

Planning & Resource Guide

ail.ca

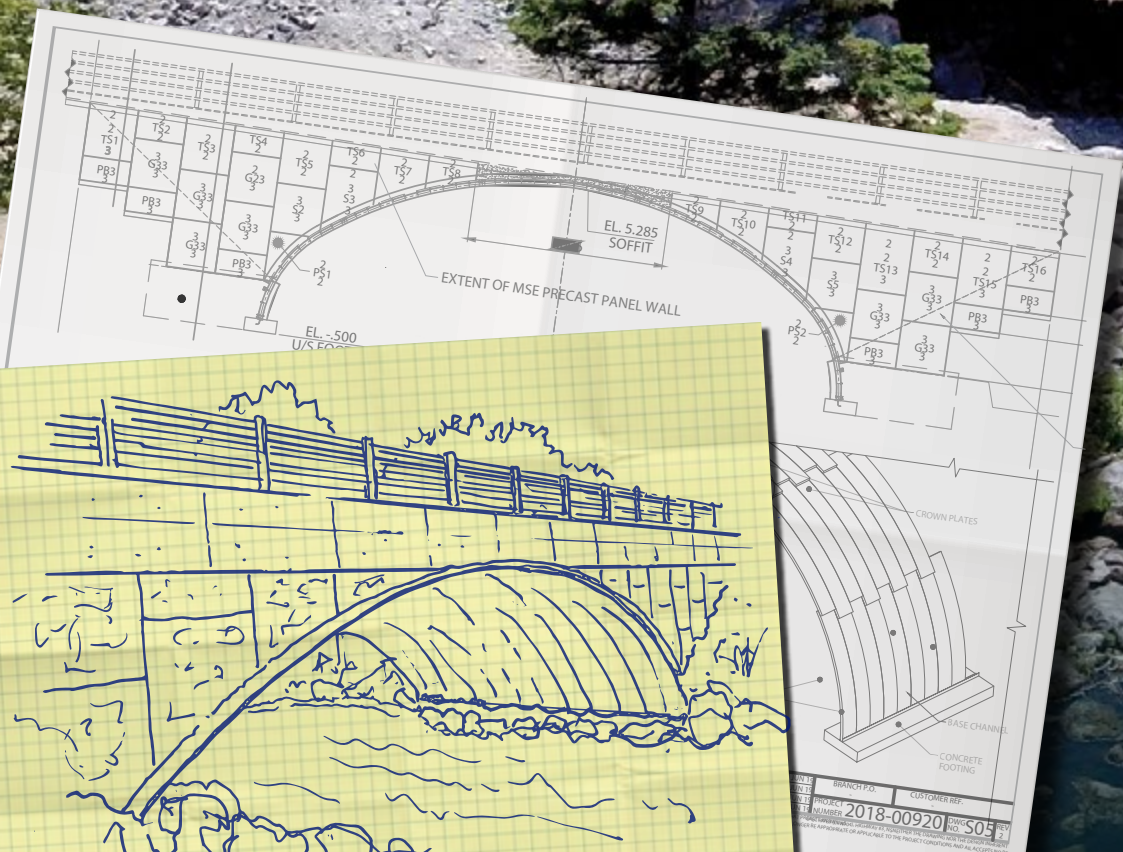
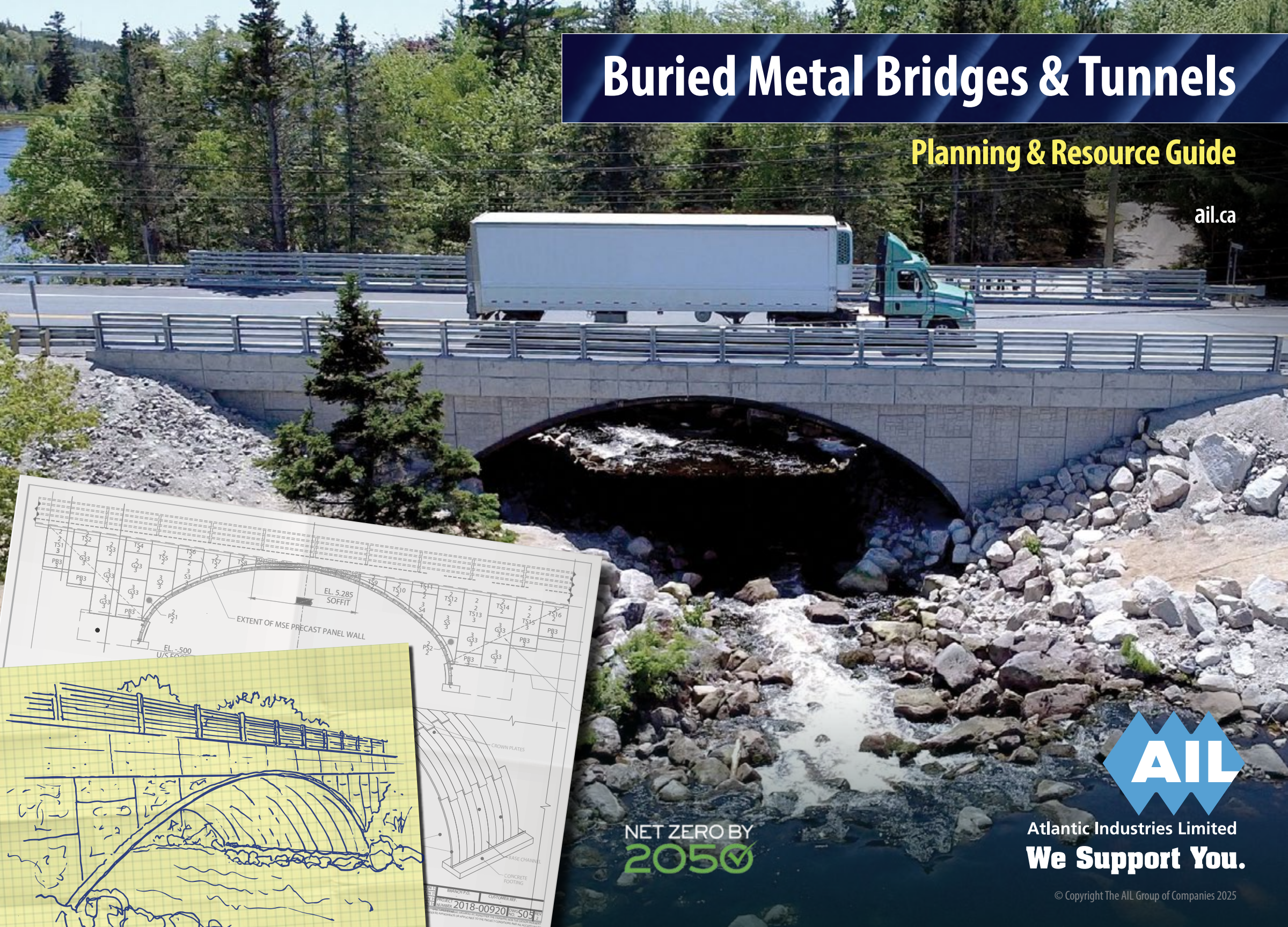

NET ZERO BY
2050 ✓



Atlantic Industries Limited
We Support You.

© Copyright The AIL Group of Companies 2025



ULTRA·COR[®]
Structural Steel Plate



Innovative Ultra-Cor[®] creates the world's largest metal buried bridge span: 32.39 m, Dubai, UAE.

[View Project Profile](#)



We're all about support.

Engineered structures from Atlantic Industries Limited (AIL) can support multiple lanes of highway traffic, the heaviest freight trains or the largest mining vehicles. However, those structures are only as strong as the people supporting them with full design and engineering services, on-time manufacturing/delivery and dependable site assistance. Our people have been supporting some of the world's largest infrastructure projects for over 60 years.

A Canada-wide network and international scope.

With a Canada-wide network of sales teams, engineering offices and manufacturing facilities, AIL is a proven project partner, ready to help you through every stage of your next project. Plus, as a member of The AIL Group of Companies, we bring a world of resources and expertise to our projects in the transportation, public works, mining, development and forestry sectors.



Efficient Buried Metal Bridges and more.

AIL offers a wide range of efficient Buried Metal Bridges — all engineered to deliver optimum performance and value for your application. We also design and supply Prefabricated Bridges, Modular Panel Bridges, Retaining Walls, Abutments and Sound Barrier Walls. By design, our complete line of Value Engineered solutions are easy to ship and install with minimal equipment and labour requirements, making them ideal for both urban and rural locations. And, as a one-stop shop, we are able to offer comprehensive packages with the design and supply of multiple components such as footings, headwalls, wingwalls, abutments, guiderails and more.

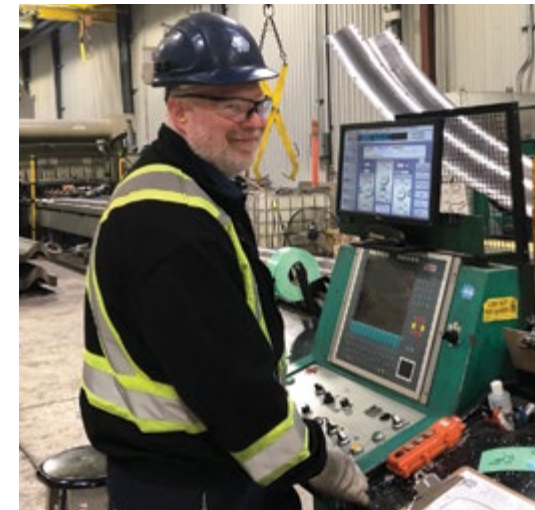



Value Engineering for a better bottom line.

The AIL Team is very experienced in Value Engineering better ways of doing things that can deliver a faster schedule and lower overall costs to your project's bottom line.

Value Engineering is a systematic method of improving the value of products and services by examining the ratio of function to cost. In short, faster installation times, lower material and maintenance costs, less expensive materials and services or better functions are utilized in projects without sacrificing quality, safety or performance.

Increasingly, many of today's DOTs, municipalities and other infrastructure decision-makers are open to considering Value Engineered alternatives in their tendering policies. Some of AIL's recent Value Engineering projects have saved 25% or more on the overall project costs for the benefit of owners and other project partners.

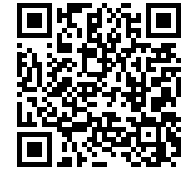

[View Value Engineering Case Studies](#)

Over 60 years of innovative thinking.

Innovative thinking has been the cornerstone of our success since 1965. The AIL Group of Companies is committed to product research and development, with solutions that are endorsed by engineers around the world.



Canada's Bridge & Infrastructure Company

For project assistance call 1-877-245-7473 • Outside Canada +1-778-355-7000



Pipe & Drainage Solutions



Retaining Walls & Abutments



Sound Barrier Walls

[View All Products](#)



AIL offers a complete range of Buried Metal Bridge products.

We manufacture a complete range of plate bridges to handle every need and budget. Our corrugated metal structures ship and install easily with local crews and equipment.

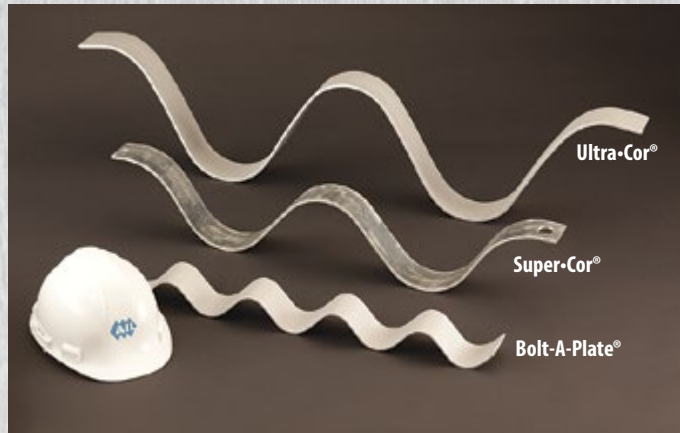

A structure for every application.

We specialize in Value Engineering cost-effective solutions for applications of all types. Our high-quality products, engineering excellence and innovative designs are key to delivering the best results for our clients.



Ultra-Cor® creates the world's strongest Buried Metal Bridges.

With the introduction of Ultra-Cor®, AIL has taken engineered structural plate to new dimensions in capability and performance. Ultra-Cor® combines all the advantages of lightweight construction with previously unheard-of strength and durability for the largest and most extreme applications. Spans can exceed 35 m (115').



Super-Cor® is ideal for medium-sized applications.

Super-Cor® combines the advantages of lightweight construction with the superior strength and durability of deep-corrugated, galvanized steel to create corrugated buried bridges for heavy loads. Spans can reach up to 25 m (82').



Bolt-A-Plate® is recommended for smaller applications.

For a strong, effective bridging alternative, Bolt-A-Plate® is the product of choice for its light weight, strength and versatility. It is available in a wide variety of shapes and sizes. Spans range from 1.5 m (5') to 10 m (33').



Dur-A-Span® is ideal for saltwater and aggressive environments.

Dur-A-Span® Structural Aluminum Plate is lightweight, strong and corrosion/abrasion-resistant with a design service life of 100+ years. It is a cost-effective choice that has been proven in over 15,000 structures worldwide. Spans can reach 12 m (40').



Pre-engineered Buried Metal Bridges without the need for concrete footings.

AIL GRS Bridges are patented buried arch systems featuring a soil/steel geotextile composite structure. Dead and live loads are supported by the reinforced soil structure and natural or improved subgrade soils. They are typically shipped on a single flatbed trailer and constructed using local materials and conventional road construction equipment.

Two-Flange Tunnel Liner Plate

Two-Flange Tunnel Liner Plate makes underground structures stronger, safer.

AIL's Two-Flange Tunnel Liner Plate provides optimum stability and protection when constructing new tunnels and relining structures under highways and railroads and relining vertical shafts.

For project assistance call 1-877-245-7473
Outside Canada +1-778-355-7000

From the smallest structure to the world's largest Buried Metal Bridge — AIL has it covered.

BOLT·A·PLATE®
Structural Steel Plate

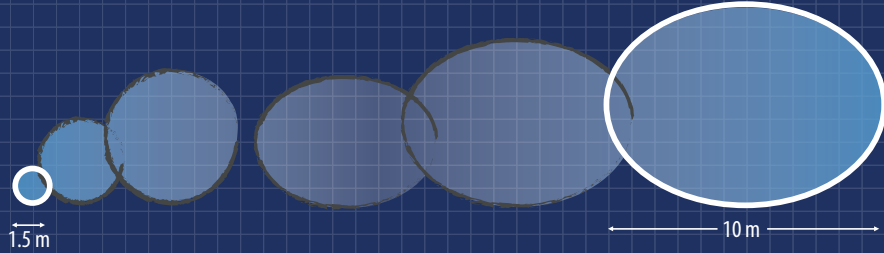

With spans that can reach 10 m, Bolt-A-Plate® is recommended for smaller applications. Available in a wide range of shapes.



SUPER·COR®
Structural Steel Plate

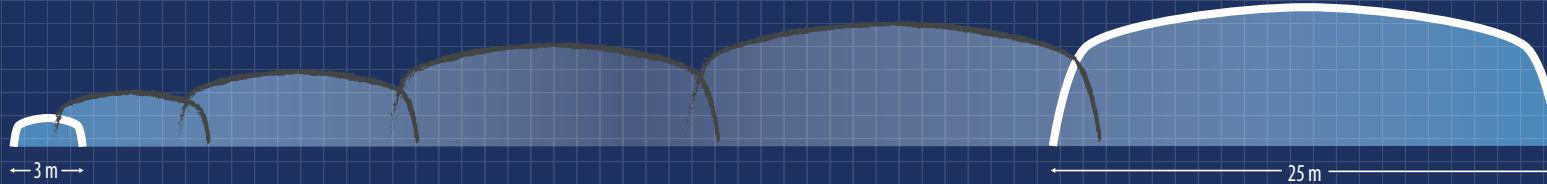

Deep-corrugated Super-Cor® is ideal for medium-sized applications, with spans able to reach 25 m. Available in a wide range of shapes.

ULTRA·COR®
Structural Steel Plate

The ultra-deep corrugations of Ultra-Cor® make it ideal for the largest and most extreme applications, with spans able to exceed 35 m. Available in a wide range of shapes.

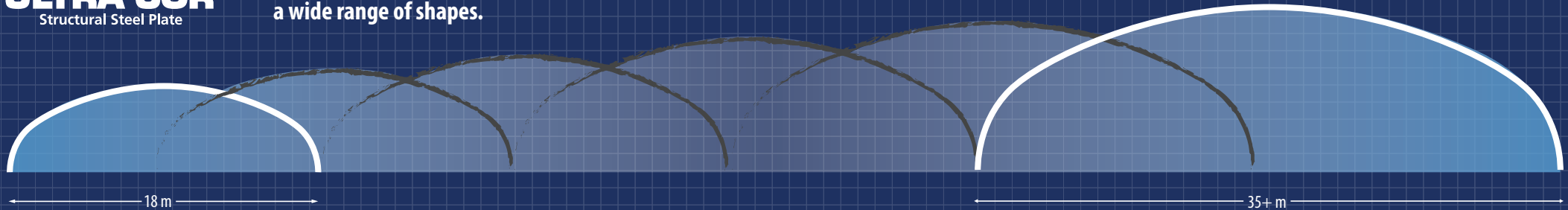

Buried Metal Bridge Benefits

All's Buried Metal Bridges offer many advantages over concrete structures and girder style bridges.

- ▶ Save time and money on all aspects of the structure: material, shipping, foundations and footings, labour and equipment and life cycle maintenance
- ▶ “Greener” alternatives to concrete structures
- ▶ Seamless, wider and safer road surface than girder style bridges
- ▶ More flexible and resilient to climate change weather events than concrete structures
- ▶ Minimized site impact
- ▶ Ideal for Accelerated Bridge Construction
- ▶ Customized geometries to meet site-specific requirements
- ▶ Lightweight, easy to ship and install
- ▶ Larger, stronger for the heaviest loads
- ▶ Can accept a range of backfill materials
- ▶ A proven technology with global acceptance
- ▶ Value Engineering opportunities
- ▶ Equally suitable for urban, rural and remote locations
- ▶ Enhanced aesthetic treatments inside and out



Buried Steel Bridges have a substantially lower life cycle carbon footprint than concrete bridges.

- ▶ Steel is the world's most recycled material*
- ▶ Less energy is used in the production and shipping of Buried Steel Bridges than concrete bridges
- ▶ Buried Steel Bridges can be built in significantly less time, reducing disruption time and detours and expediting construction schedules
- ▶ Buried Steel Bridges require less maintenance than concrete beam bridges
- ▶ Zinc used in galvanizing is a naturally occurring material and is 100% recyclable**

*Reference: www.aisc.org

**Reference: <https://galvanizeit.org/hot-dip-galvanizing/is-galvanizing-sustainable/hdg-environmental-advantages>



Seamless, wider and safer road surface,
Highway 3, East River, Nova Scotia

Virtually no maintenance; minimized life cycle costs.

- ▶ Eliminates recurring life cycle costs to maintain and repair bridge decks, expansion joints, bearings, girder fatigue, de-icing agent corrosion issues, concrete durability, fracture issues, approach slabs and freeze/thaw or wet/dry cycles
- ▶ No differential settlement “bridge bump” to maintain between decks and approach slabs
- ▶ Wider spans eliminate need for bridge piers that restrict hydraulic flow and trap debris
- ▶ Open-bottom shapes can offer longer design service life
- ▶ Design service life can exceed 75 years with protective coatings
- ▶ Structure length can be extended to accommodate future road widening; increased functional service life

Seamless, wider and safer road surface than girder style bridges.

- ▶ Allows roadway construction to extend subgrade materials directly over buried bridge elements
- ▶ Road section provides uniform driving lane and shoulder widths over buried bridges
- ▶ Pavement structure is continuous and seamless
- ▶ No bridge deck freezing issues
- ▶ No freeze/thaw differential with roadway approaches
- ▶ No need to narrow roadway at crossing

More flexible and resilient than concrete structures or girder style bridges.

- ▶ Unmatched performance, especially in less-than-ideal foundation conditions
- ▶ Settlement tolerance is much higher than concrete structures or girder style bridges
- ▶ Little differential movement, settlement or frost heave between buried bridge and adjacent approach fills
- ▶ Headwalls and wingwalls offer more resiliency in flood events
- ▶ Geotextile Reinforced Soil (GRS) backfill technology also increases resiliency

Buried Metal Bridge Benefits



Minimized site impact.

- ▶ Usually no invert, resulting in a longer service life
- ▶ Minimal impact on streambeds and habitat
- ▶ Wide-span, open-bottom designs allow for natural streambeds with excellent open-flow hydraulic and fish passage properties
- ▶ Buried Metal Bridges will not leach harmful chemicals or compounds into the water or ground, which is often a concern with concrete structures



Lightweight, easy to ship and install.

- ▶ Lightweight, nestable components are easy to ship anywhere
- ▶ Lower structure, foundation and installation costs compared to concrete structures and girder style bridges
- ▶ Can be constructed with local crews and equipment
- ▶ Owners with in-house resources can complete some or all of the construction
- ▶ Lighter-weight components eliminate need for larger capacity (or multiple) lifting devices
- ▶ Many applications can be built within accelerated construction timelines



Ideal for Accelerated Bridge Construction programs.

- ▶ Approval drawings can be provided quickly
- ▶ Some structures can be delivered within days or weeks of order
- ▶ Many structures can be assembled in just a few days
- ▶ Staged construction can avoid full road closure

ALL's Buried Metal Bridges offer customized geometries to meet site-specific requirements.

This includes various structural plate product options, shapes, sizes and bevelled or skewed ends.

The more distance there is between the bottom of a structure and the road elevation above, the more cost-effective a buried bridge can be.

As an example, in the top illustration a 3 m (10') wide stream with sloped embankments passing 6 m (20') below the proposed road elevation might require a girder style bridge with a span of 30 m (100') or more.

Alternatively, in the bottom illustration a 14 m (46') span Buried Metal Bridge could achieve the site and hydraulic objectives with significant time and cost savings.

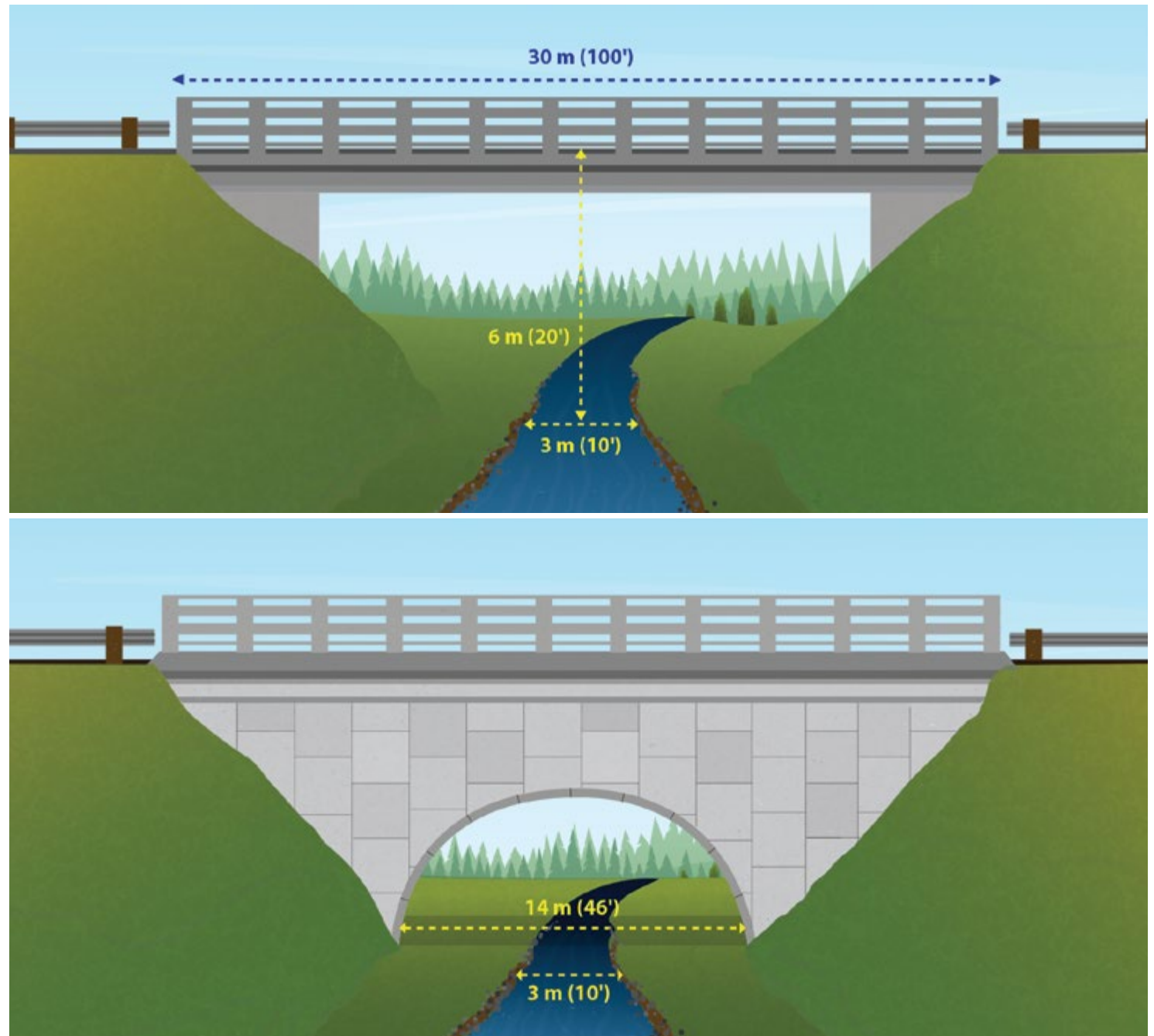

Buried Metal Bridge Benefits



Larger, stronger for the heaviest loads.

- ▶ Thicker steel and larger corrugation profiles with much higher design strength
- ▶ Product of choice for extreme loads, construction loads or repetitive overloads
- ▶ Also shielded from dynamic load effects (wind and vehicular)
- ▶ Wider spans, more applicable for bridge applications
- ▶ Handles larger hydraulic flows
- ▶ 50% thicker galvanizing, adding to service life



Can accept a range of backfill materials.

- ▶ The bridge structure and the backfill materials act together to support the loads
- ▶ Ideal backfill materials are often available on or near the site at a low cost
- ▶ If not, less-than-ideal backfill materials (including on-site materials) can often be considered
- ▶ Use of local backfill materials yields significant cost savings and smaller carbon footprint due to reduced trucking

Buried Metal Bridges are a proven technology with global acceptance.

With many thousands of installations worldwide over the last 60 years, Buried Metal Bridge design and analysis continues to evolve, as their behaviour is better understood.

Collaborative efforts by many academics at prominent research facilities lead the way through advanced finite element modeling initiatives, which are validated by rigorous field and laboratory testing programs.

Since AIL first introduced our deep-corrugated structural plate solutions over 30 years ago, there has been growing global acceptance of this technology. Numerous countries have adapted their national bridge code standards and specifications to recognize and support large span Buried Metal Bridge design

Canada

CSA S6:19, Canadian Highway Bridge Design Code, Section 7, Buried Structures CSA G-401, Corrugated Steel Pipe Products

USA

AASHTO LRFD Bridge Design Specifications, Ninth Edition, 2020 ASTM A761/A761M, A796/A796M

Australia and New Zealand

AS/NZS 2041.1, 2041.2, 2041.6

Sweden

TRITA-BKN Report 112, Design of Soil Steel Composite Bridges

Value Engineering opportunities.

AIL is experienced in finding alternative solutions that offer your projects the same functionality and quality at a better value. We call it Value Engineering.

Value Engineering is a systematic, organized approach to providing necessary functions in a project on a faster schedule and at the lowest cost. It promotes the substitution of materials and methods with less expensive alternatives without sacrificing functionality, performance or safety.

Value Engineering can be achieved in any number ways:

- ▶ It could be the decision to choose a Buried Metal Bridge instead of a concrete structure
- ▶ It could be reducing the polymer-coated areas of a Buried Metal Bridge to only the vulnerable areas
- ▶ It could be formulating a specifically engineered backfill from a local source when quarries are too far away
- ▶ Or, it could even be adding innovative soil reinforcement to a buried structure's bevelled ends to save time and money by eliminating the need for concrete collars or false-work interior bracing during backfill



Take a look at our
Value Engineering Case
Studies to learn more.

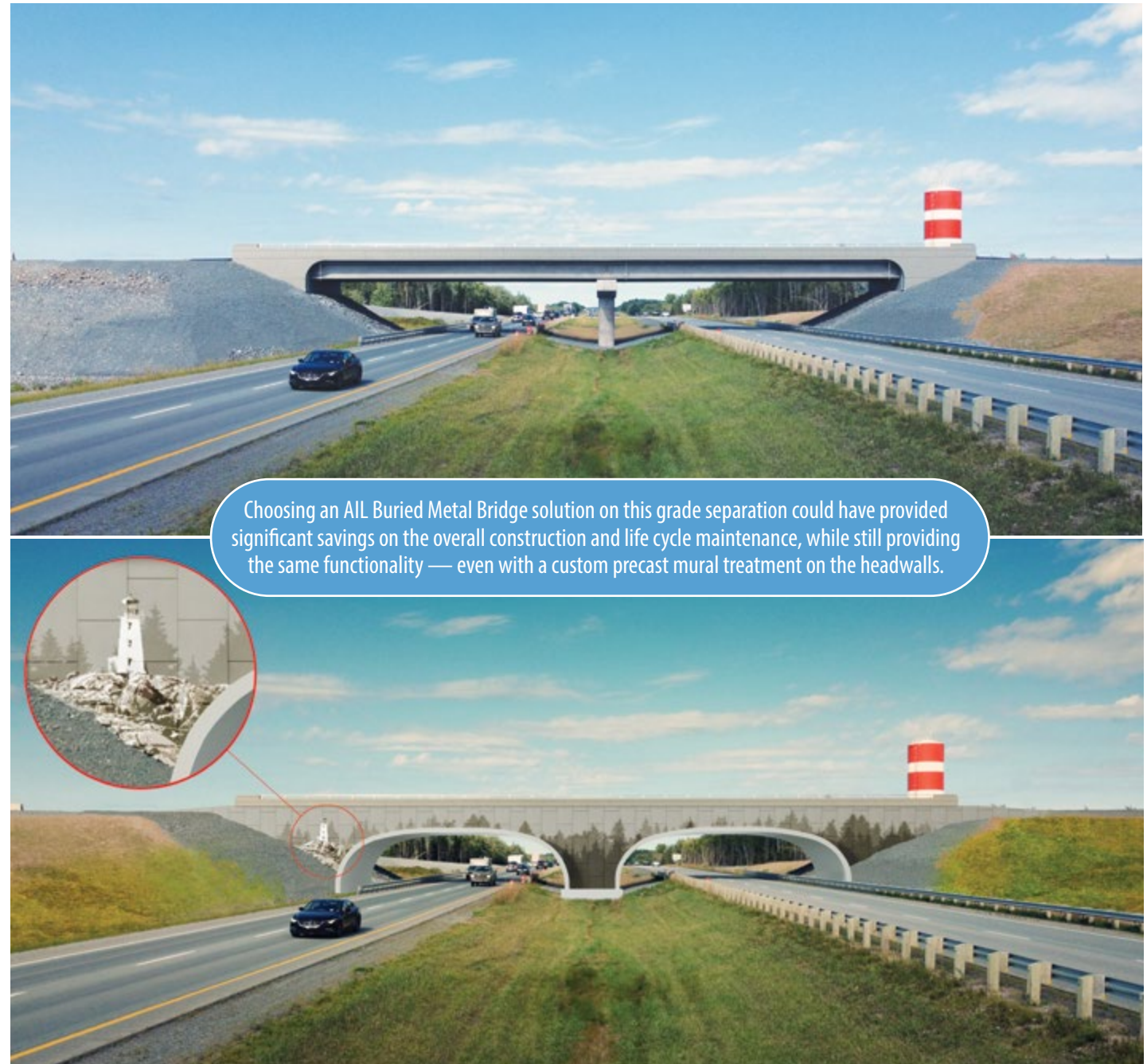

Recommended for

- ▶ Box Structures
- ▶ Bridges and Tunnels
- ▶ Bridge Rehabs
- ▶ Conveyor Covers and Overcasts
- ▶ Fish Passages
- ▶ Grade Separations
- ▶ Heavy Haul Road Crossings
- ▶ Portals and Canopies
- ▶ Road or Rail Underpasses
- ▶ Stockpile and Escape Tunnels
- ▶ Storage Structures
- ▶ Stream Crossings
- ▶ Underground Structures
- ▶ Vertical Shafts and Vent Raises
- ▶ Wildlife Crossings

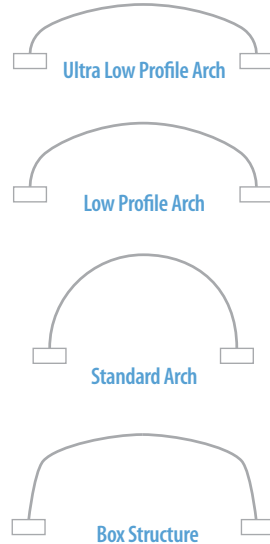

Recommended for larger applications.

With the introduction of Ultra-Cor,[®] AIL has taken engineered Buried Metal Bridges to new dimensions in capability and performance. As the world's deepest corrugation profile, Ultra-Cor[®] combines all the advantages of lightweight construction with previously unheard-of strength and durability to create the largest Buried Metal Bridges in the world today.

With an impressive 500 mm (19.6") pitch and 237 mm (9.5") depth, its ultra-large corrugations allow it to reach greater spans and withstand the heaviest of loads. And, just like all AIL engineered solutions, Ultra-Cor[®] ships and installs easily with minimal equipment and labour requirements.

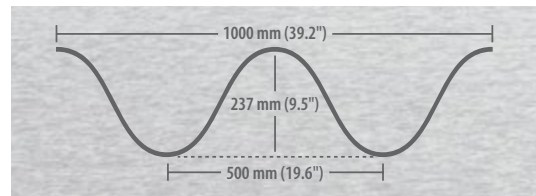

- ▶ The world's strongest corrugated steel plate
- ▶ Handles extreme loadings
- ▶ Spans can exceed 35 m (115')
- ▶ Stockpile heights can reach greater than 30 m (98')
- ▶ Corrugation profile of 500 mm (19.6") pitch × 237 mm (9.5") depth
- ▶ Bottomless designs are environmentally friendly
- ▶ Available with tested and approved protective coating systems (See page 18)
- ▶ Designed and manufactured to National Standards at our third-party quality-certified facility ISO 9001-2015



For project assistance call 1-877-245-7473
Outside Canada +1-778-355-7000



[View Project Profile](#)



Bow Valley Gap Wildlife Overpass, Canmore, AB



[View Project Profile](#)



Highway Interchange, St. John's, NL



[View Project Profile](#)

Stream Crossing, Ladysmith, BC

Recommended for

- ▶ Box Structures
- ▶ Bridges and Tunnels
- ▶ Bridge Rehabilitation
- ▶ Grade Separations
- ▶ Heavy Haul Road Crossings
- ▶ Portals and Canopies
- ▶ Road or Rail Underpasses
- ▶ Stockpile and Escape Tunnels
- ▶ Storage Structures
- ▶ Stream Crossings
- ▶ Wildlife Crossings

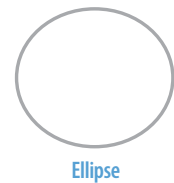
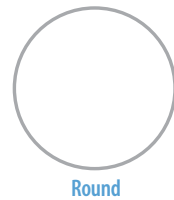

Suitable for medium-sized applications.

Super-Cor® combines the advantages of lightweight construction with the superior strength and durability of deep-corrugated, galvanized steel to create some of the world's largest corrugated metal structures. With thousands of structures since the early 1990s, Super-Cor® is a proven choice for resilient and sustainable bridging solutions with a lower carbon footprint than concrete.

The larger annular corrugations in Super-Cor® provide nine times the stiffness of conventional structural plate, allowing it to withstand the heaviest of loads. Not only is Super-Cor® the most versatile and economical corrugation on the market, it is also the most internationally accepted and widely used.

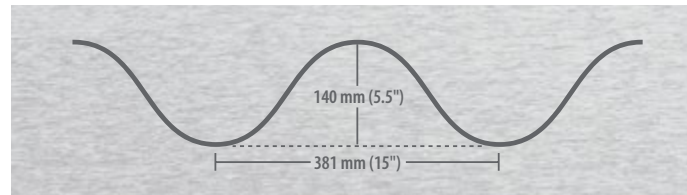

- ▶ Handles extreme loadings
- ▶ Optimal for spans of 6 m (20') to 20 m (65')
- ▶ Corrugation profile of 381 mm (15") pitch × 140 mm (5.5") depth
- ▶ Available in steel thicknesses of 4 mm (.16") to 8 mm (.32")
- ▶ Available in: Box Structures; Standard, Low or High Profile Arches; Rounds and Ellipses
- ▶ Bottomless designs are environmentally friendly
- ▶ Available with tested and approved protective coating systems
- ▶ Designed and manufactured to National Standards at our third-party quality-certified facility ISO 9001-2015

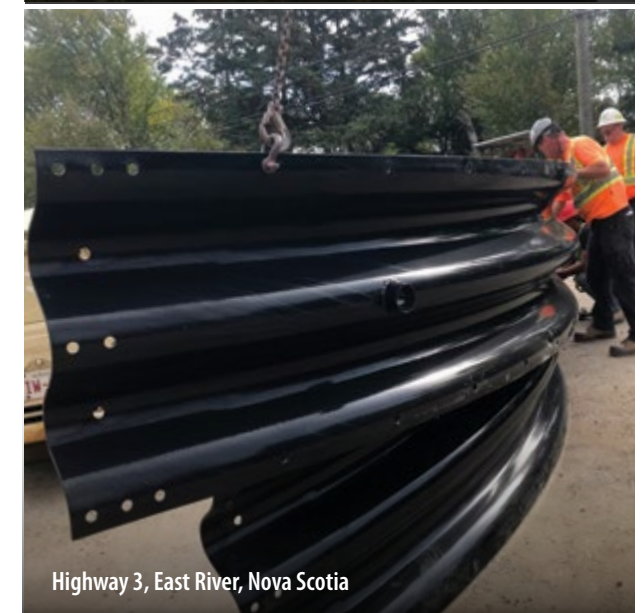
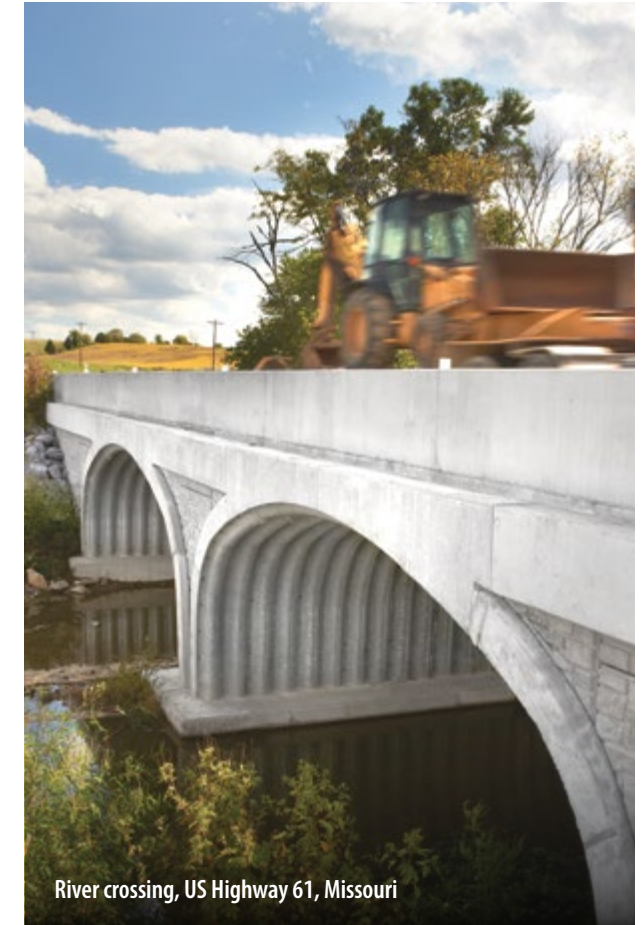



Take a 360°
Video Tour



Stream crossing, Highway 3, East River, Nova Scotia



View Project Profile

Rail overpass, Highway 101, Windsor, Nova Scotia



Stream crossing, Fanny Bay, British Columbia



Stream crossing, Highway 99, Enterprise Creek, British Columbia



BOLT-A-PLATE®

Structural Steel Plate

Recommended for smaller applications.

For a strong, effective bridging alternative, Bolt-A-Plate® is the product of choice for its light weight, strength and versatility. Bolt-A-Plate® is available in a wide variety of shapes and sizes.

It is perfect for highly economical Buried Metal Bridge and drainage structure construction or replacement, as well as many other applications in the transportation, public works, mining and forestry sectors.

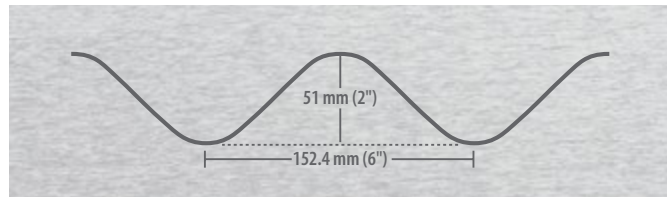

- ▶ Industry-standard, hot-dip-galvanized, corrugated structural steel plate for smaller applications
- ▶ Spans of 1.5 m (5') to 10 m (33')
- ▶ Corrugation profile of 152.4 mm (6") pitch × 51 mm (2") depth
- ▶ Bottomless designs maintain natural streambeds
- ▶ Can reline older structures
- ▶ Available with tested and approved protective coating systems (See page 18)
- ▶ Designed and manufactured to National Standards at our third-party quality-certified facility ISO 9001-2015



Fish Passage Culvert, Fundy Trail Parkway, New Brunswick



Culvert reline, Compton, Quebec



River crossing, Hays County, Texas

- Recommended for
- ▶ Bridges and Tunnels
 - ▶ Conveyor Covers and Overcasts
 - ▶ Culvert Relines
 - ▶ Fish Passages
 - ▶ Grade Separations
 - ▶ Heavy Haul Road Crossings
 - ▶ Portals and Canopies
 - ▶ Road or Rail Underpasses
 - ▶ Stockpile and Escape Tunnels
 - ▶ Storage Structures
 - ▶ Stream Crossings
 - ▶ Underground Structures
 - ▶ Utilidor Systems
 - ▶ Vertical Shafts and Vent Raises

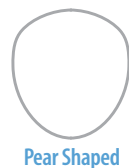
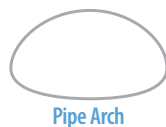
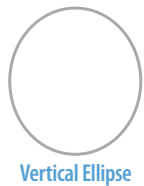
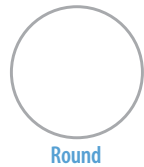



Horizontal Ellipse Culvert, Watson Lake, Yukon Territory



Culvert, Casselman, Ontario



Active Transportation Underpass, Calgary, Alberta



Flood Plain Culverts, Highway 19 Connector, Courtenay, British Columbia



[View Project Profile](#)



Culvert, Chetwynd, British Columbia



Recommended for

- ▶ Buried Bridges
- ▶ Culverts
- ▶ Fish Passages
- ▶ Grade Separations
- ▶ Road or Rail Underpasses
- ▶ Storm Sewers
- ▶ Stream Crossings

Premium coatings to extend the service life of structures in aggressive environments.

Building on the years of proven performance of polymer-coated corrugated steel pipe, AIL has partnered with some of the world's leading developers of coatings to provide Best·Kote™ Structural Plate Coating. For extended service life of Super·Cor® and Bolt-A-Plate® structures, Best·Kote™ offers superior protection and long-term durability. Ask about our epoxy coating options for Ultra·Cor®.

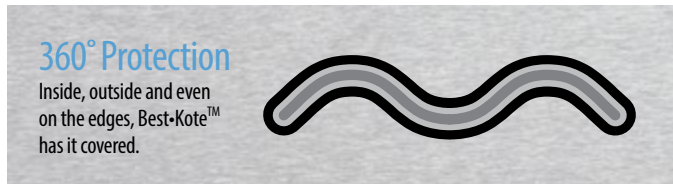

- ▶ + 75 YEAR service life
- ▶ Economical solution for extended service life of structure; ideal for aggressive environmental conditions
- ▶ Protects against corrosion, abrasion and inorganic acid, salts or alkali (diluted)
- ▶ Can be applied to all or part of a structure
- ▶ Available on Super·Cor® or Bolt-A-Plate® Structural Steel Plate
- ▶ Ask about our epoxy coatings for Ultra·Cor®
- ▶ Special bolts and fasteners maintain integrity of coating during assembly

+ 75 year service life



Stream crossing, Highway 3, East River, Nova Scotia



Bridge replacement, Town of Essex, Ontario



View Project Profile



Polymer System

This coating system provides two layers of protection — a zinc-rich base layer and a Polymer finish layer on top of the steel plate.

Polymer Finish Layer

Ethylene Acrylic Acid Polymer provides superior resistance to corrosion, abrasion and inorganic acid, salts or alkali (diluted).

Zinc-Rich Base Layer

Provides excellent corrosion resistance and barrier protection.

Steel Plate

OVER
75
YEAR
SERVICE LIFE

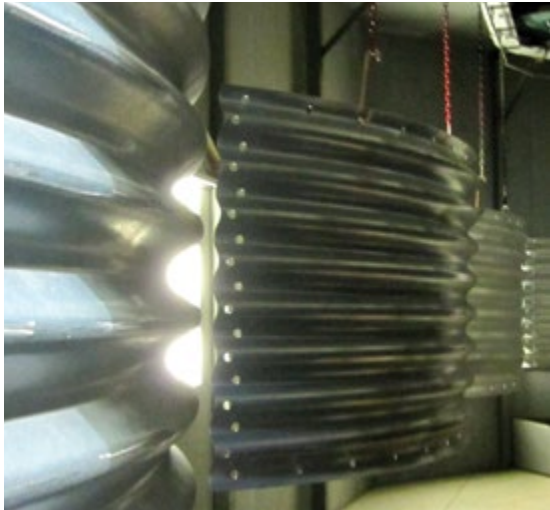

Culvert reline, Caledon, Ontario



Recommended for

Saltwater and Aggressive Soil Applications, such as:

- ▶ Culverts
- ▶ Culvert Relines
- ▶ Fish Passages
- ▶ Road Salt and Other Storage Structures
- ▶ Stream Crossings



Standard Arch



High Profile Arch



Box Structure

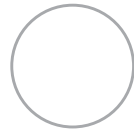

Round

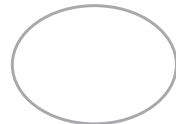

Horizontal Ellipse



Pipe Arch

For corrosion/abrasion resistance.

Lightweight, strong and corrosion/abrasion resistant, Dur-A-Span® goes the distance in over 15,000 structures worldwide — beating the usual heavyweight contenders, like precast concrete, on overall performance and cost.

And now, thanks to our innovative reinforcing rib technology, Dur-A-Span® can go even further (and wider) to outperform all challengers.

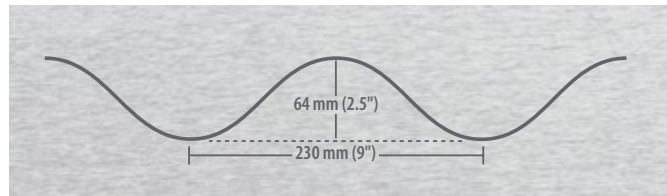

- ▶ Corrosion/abrasion-resistant solid aluminum alloy structural plate ideal for saltwater and aggressive soil environments
- ▶ Lightweight and strong
- ▶ Spans can reach up to 12 m (40')
- ▶ Corrugation profile of 230 mm (9") pitch × 64 mm (2.5") depth
- ▶ Bottomless designs maintain natural streambeds



Stream crossing, Town of Plympton-Wyoming, Ontario



Culvert replacement, New Brunswick



[View Project Profile](#)



Stream crossing, Town of Plympton-Wyoming, Ontario



Stream crossing, Trans-Canada Highway, New Brunswick



Fish passage, CN Rail, Miramichi, New Brunswick



Culvert reline, Alaska Highway, British Columbia

Urbanscapes that escape the ordinary.

Growing towns and cities need to both create new infrastructure and replace old. Finding the “sweet spot” between simple function and noteworthy design is, in itself, a daunting task. Balancing symmetry, proportion and harmony with specific urban environments is taking it to another level all together.

Where design aesthetics meet economy and sustainability

AIL's Urbanscape Infrastructure Solutions offer progressive urban planners and landscape architects the opportunity to bring enhanced aesthetics to their projects with the confidence that they are making both fiscally prudent and environmentally responsible choices that will benefit their communities well into the future.

Part of the green scene.

Preserving and enhancing urban green space is important. Consider surrounding one of our Buried Metal Bridges or Tunnels with Green Walls created on battered, wire-faced configurations of our MSE Retaining Wall Systems. Inherently sustainable and resilient, these economical solutions provide many decades of maintenance-free service.





Gracefully sweeping curves.

If site geometries permit, bevelled ends are a very natural way to help a structure be one with the natural contour of the land. Sloped embankments can be left green or finished with natural stone. Any variety of architectural coping or collar treatments can be integrated to accentuate their gracefully sweeping curves.



Custom safety rail



Custom textured collar, South Korea



Stylish from the ground up.

The architectural aesthetics of our MSE Precast Panel Headwalls can be extended to the inside by creating textured concrete halfwalls running the length of the structure. This hybrid design effectively sets the buried bridge on a raised engineered concrete foundation.



Source: ViaCon Group



Source: ViaCon Group

Design Ideas Gallery

A palette of possibility.

Our Buried Metal Bridges and Tunnels are usually provided with a Galvanized or Polymer-Coated Finish and left that way for low-maintenance service. However, they can also be custom-coloured to provide a brighter interior or to create unique artistic installations. With a little inspiration, the sky's the limit!

Transforming the interior.

Acoustic paneling can transform the interior, break up space, deaden sound and hide utility pipes and electrical conduits.

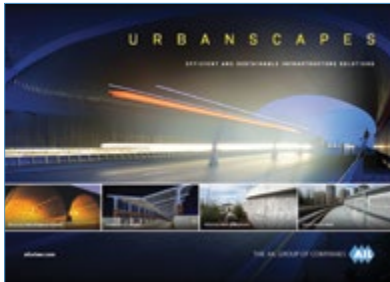

Download our Urbansapes
Idea Book on ail.ca





Creative illumination.

Beyond safety and security, light can invoke feelings of peace, harmony and creativity. With today's modern LED lighting technologies, light can be used to accentuate a structure's geometry and create a welcoming and memorable experience for users.

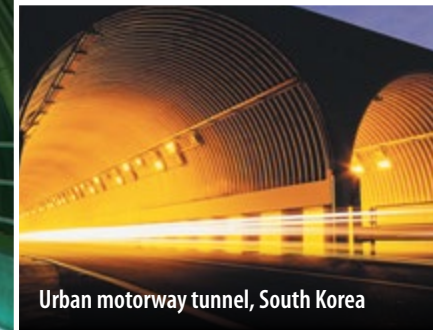

Urban motorway tunnel, South Korea



Bicycle path, The Netherlands

Source: Berghoeck



Choose your own ending.

One of the most important facets of a Buried Bridge or Tunnel are the headwalls. With a limitless array of panel sizes, colours and textures, our MSE Precast Panel Walls help every installation make a statement. A custom mural wall could tell your community's story with a sense of context and place.

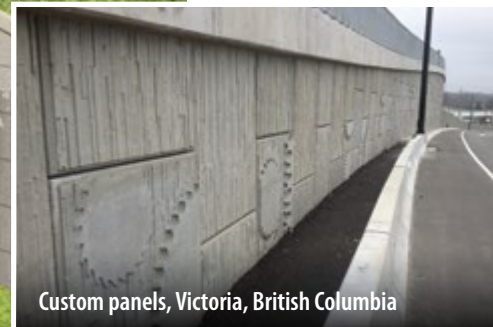

Custom panels, Victoria, British Columbia

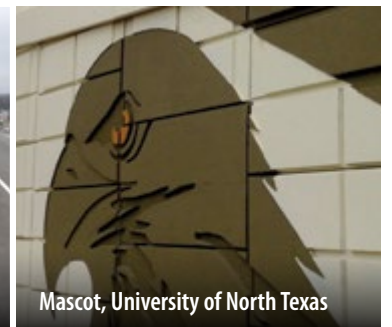

Mascot, University of North Texas

[More end treatments on next page >](#)

Design Ideas Gallery

End treatments as varied as your imagination.

Precast Panel



Cast-in-Place



Architectural Block

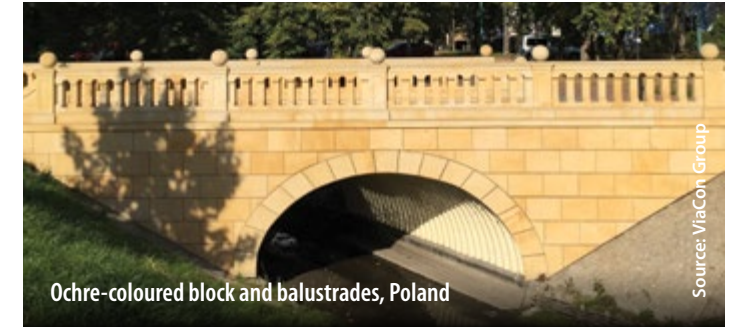

Source: ViaCon Group

Source: ViaCon Group

Source: ViaCon Group

Source: ViaCon Group



Masonry



Natural stone facing with architectural concrete detail, California



Brick headwall with precast coping, Poland

Source: ViaCon Group



Contemporary brick pattern and rail, Lakewood, Colorado



Antique brick with architectural balustrade, Indiana

Natural Stone



Natural river stone with architectural rail, near Calgary, Alberta



Natural stone to match architecture, Poland

Source: ViaCon Group



Natural river stone, Airdrie, Alberta



Flanked with natural boulders, Banff, Alberta

Mining Solutions

Resilient and sustainable, ALL Mining's infrastructure solutions are ideal for remote locations.

Staying competitive in today's economic climate means building in efficiencies from the ground up. That's why many of the world's most successful mines and quarries use efficient infrastructure solutions from ALL Mining.

We can help you save time and money in providing safe, practical work sites for your employees. By design, our custom solutions are easy to ship and install with minimal equipment and local labour, making them ideal for remote locations.



Download our ALL Mining Brochure on ail.ca



Mine Shafts, Vent Raises, Escape Ways



Road or Rail Underpasses

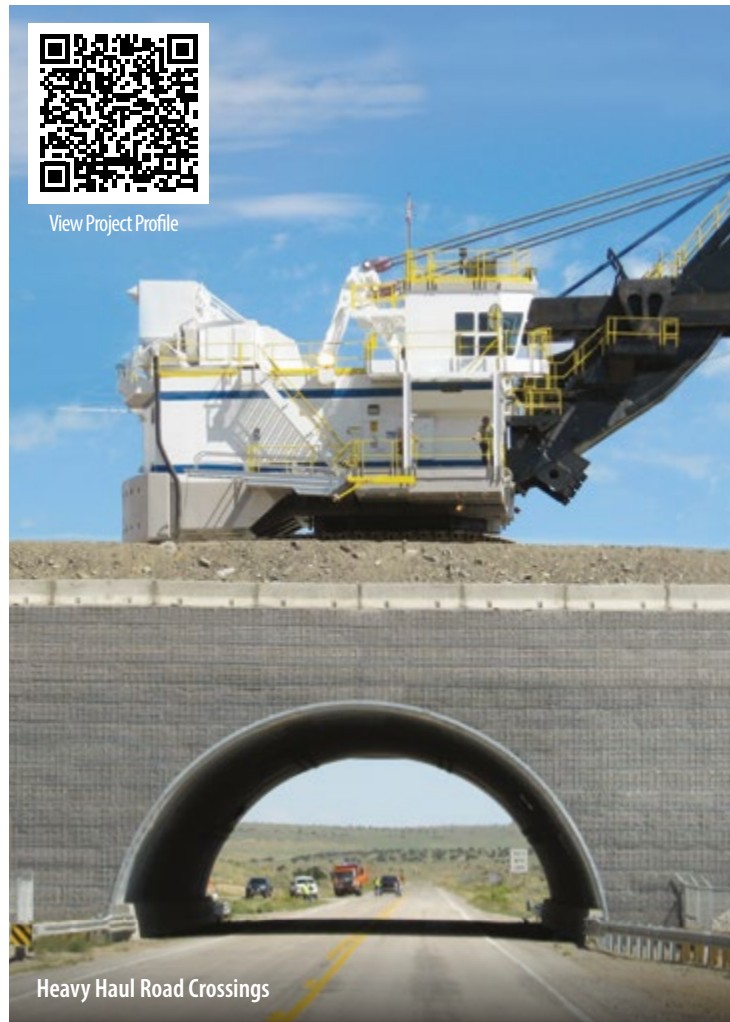

Heavy Haul Road Crossings



Portals and Canopies



Protection Structures



Stockpile and Escape Tunnels



Drainage, Ventilation and Utilidor Systems



Crusher Walls and Ramps



Mine Shafts, Vent Raises and Escape Tunnels

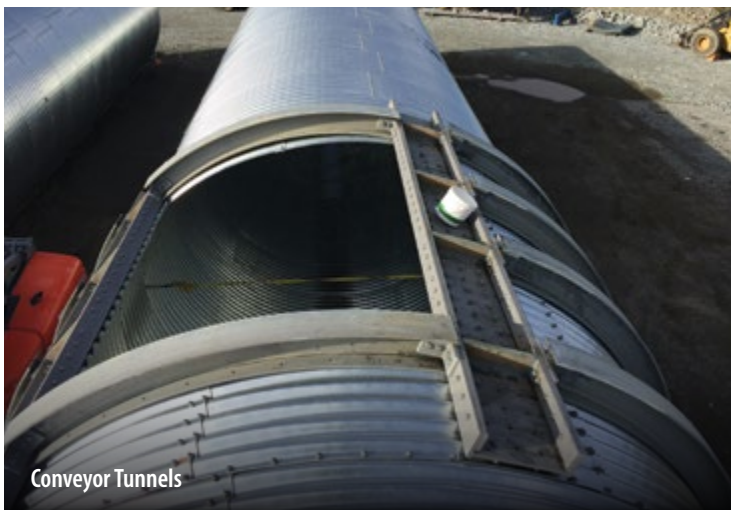

Conveyor Tunnels



Bridges and Abutments

All's Two-Flange Tunnel Liner Plate makes underground structures stronger, safer.

Two-Flange Tunnel Liner Plate provides optimum stability and protection when constructing new tunnels and relining structures under highways and railroads and relining vertical shafts.

It offers the highest continuous ring stiffness and high compression joint strength. Two-Flange Tunnel Liner Plate has an effective stiffness that is more than twice that of the same thickness (gauge) of Four-Flange Liner Plate.

Recommended for

- ▶ Tunnel Lining
- ▶ Relining (rehabilitation of failing structures)
- ▶ Vertical and Horizontal Shafts



- ▶ Minimizes installation expense
- ▶ Optimizes stability in both horizontal and vertical applications
- ▶ Excellent in strength and safety
- ▶ 10 times stiffer and 5 times stronger than traditional steel liner plate
- ▶ Handles extreme loadings
- ▶ Flanged seams instead of conventional plate overlaps

Northern Solutions

Northern infrastructure solutions need to be able to withstand the rigours of a harsh climate. They need to ship and install easily with local crews and limited equipment. They need to be flexible in order to work with changing permafrost conditions.

AIL understands the unique requirements of the North. Our lightweight and strong structural plate solutions are economical, resilient and sustainable.

By design, their components nest together for economical shipping by land or sea. They can be assembled by local construction crews with limited (or no) need for poured concrete. They create flexible and resilient structures able to handle higher settlement ranges and seismic events. And, they also have no bridge deck, expansion joints, bearings or approaches to maintain.

[View our Northern Solutions Brochure on ail.ca](http://ail.ca)



Heavy Haul Road Crossing, White Horse Creek, Northern Alberta



Limited reliance on concrete curing; fewer weather delays



Precast Concrete Footings also available



Integrated Steel Spread Footings



Geotextile Reinforced Soil (GRS) Bridge, Northern British Columbia

All Geotextile Reinforced Soil (GRS) Bridges put the dirt to work.

GRS Bridges are quick-install systems developed for the forestry, resource and transportation sectors. GRS Buried Bridges are usually constructed using local materials and equipment. These fish- and wildlife-friendly solutions require no concrete footings or pile foundations, are scour and piping resistant and are very quick to install. Dead and live loads are supported by the surrounding GRS compacted soil mass, consisting of multiple layers of geotextile and steel anchor rods.



Steel Anchor Rods and Geotextile

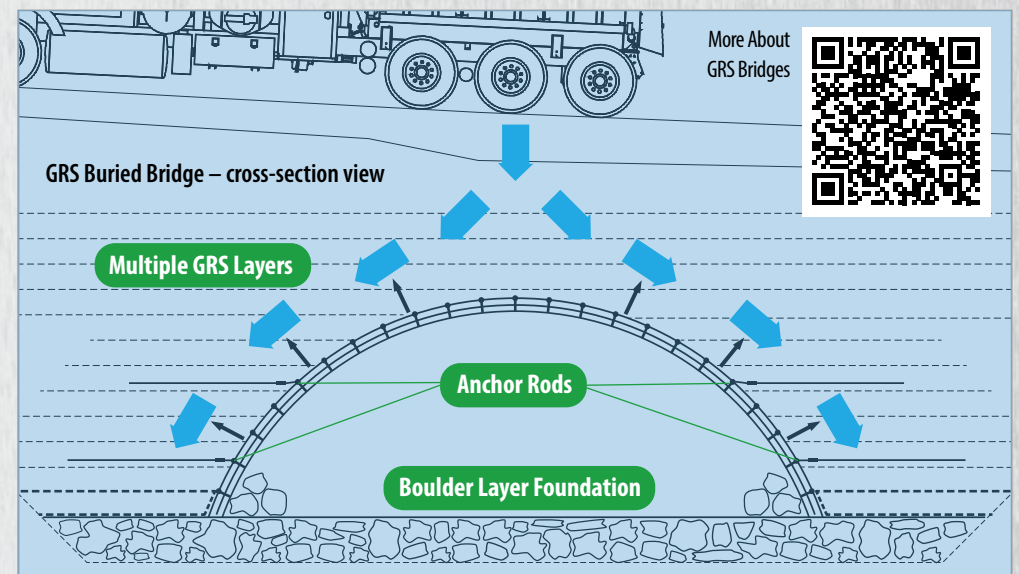

Time lapse video: Bolt-A-Plate® underpass installs in just eight days.



As part of developing the last four-lane section of Highway 97 in the Okanagan Valley, AIL designed and supplied a Bolt-A-Plate® recreational trail and wildlife underpass that installed in just eight days. Watch it take shape in this time-lapse video.



Play Time-Lapse Video

Buried Bridges are easy to install with local crews.

AIL's Buried Metal Bridges ship and install quickly and economically, with minimal equipment and labour requirements. Our technical teams will guide you through the complete project.



Precast or cast-in-place concrete footings are set over the prepared site.



The first arch segment is completely assembled on the ground.



It is then lifted into place and bolted to the footings on either side. In most cases, a boom truck is sufficient for this.

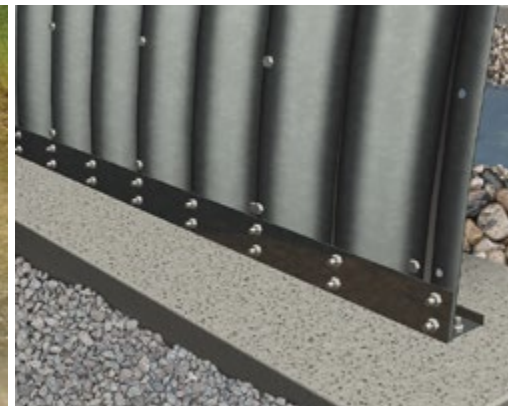

The segments bolt into base channels, integrated into the concrete.



Plates then attach individually to make up other arch segments.



If specified, reinforcement ribs are then added.

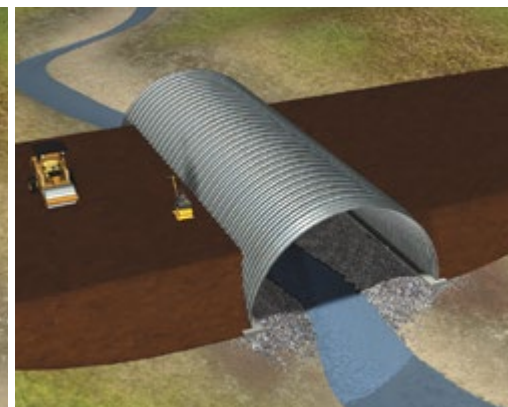

Layers of engineered backfill are added in sequential lifts.



The road surface is then completed with safety barriers.

Typical Footing Options

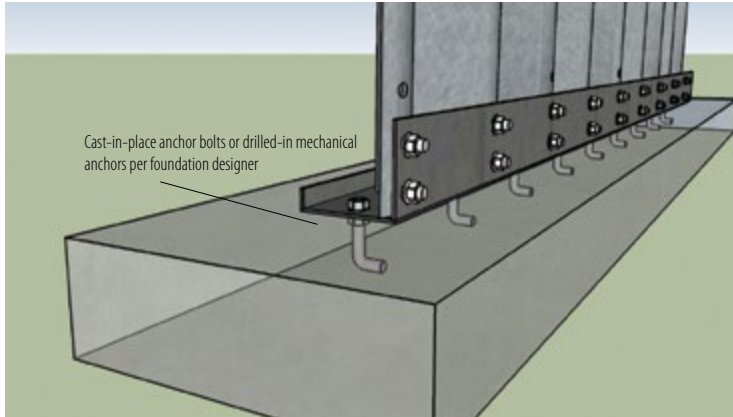

Cast-in-Place Concrete Footing with Base Channel

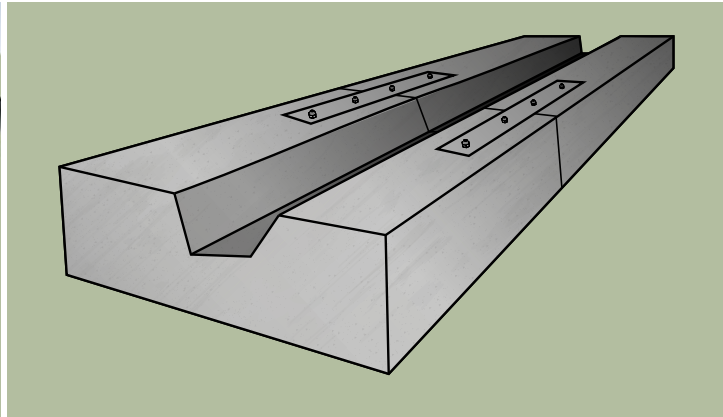

Precast Concrete Footings



Corrugated Steel Footing

Typical End Treatments and Customizations

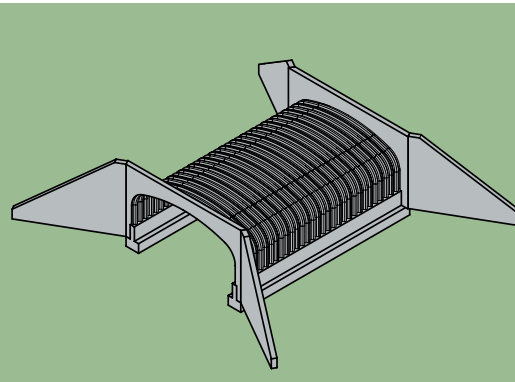
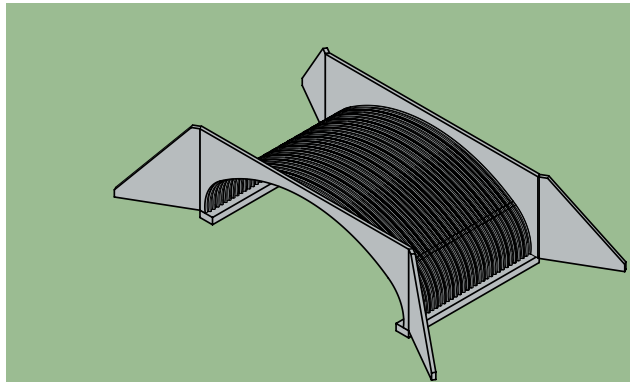

Headwalls and Wingwalls made from AIL's MSE Precast Panel Walls or Wire Walls. Other options available, see pages 26 and 27.

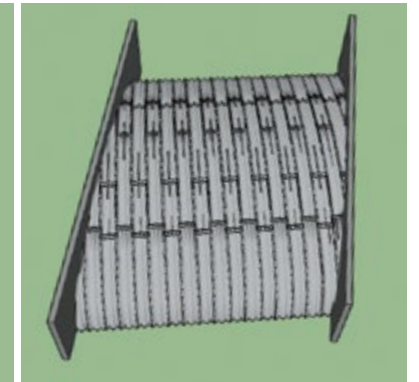
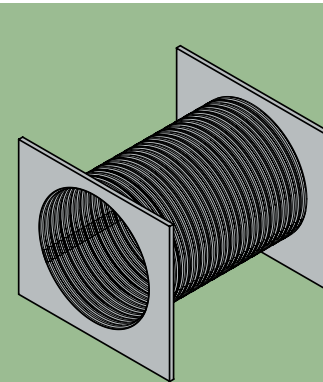

Skew with Headwall

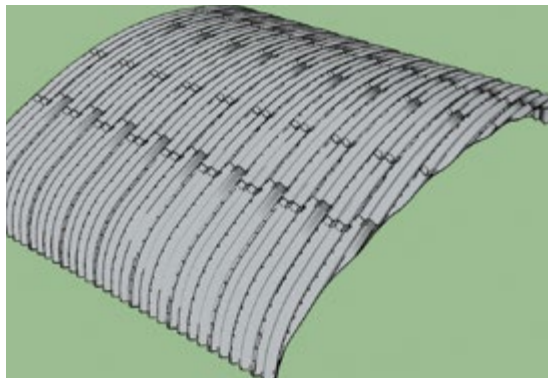

Skew

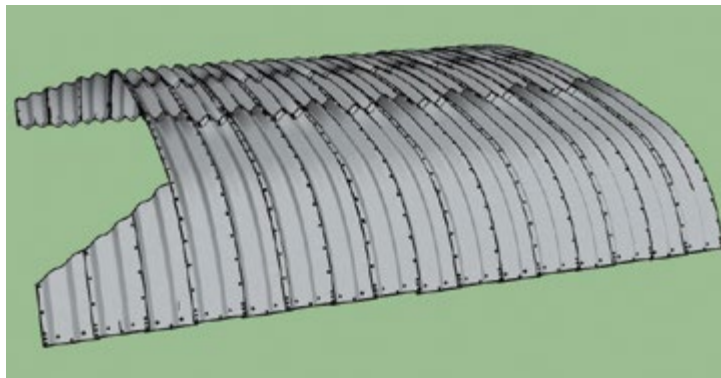

Step Bevel

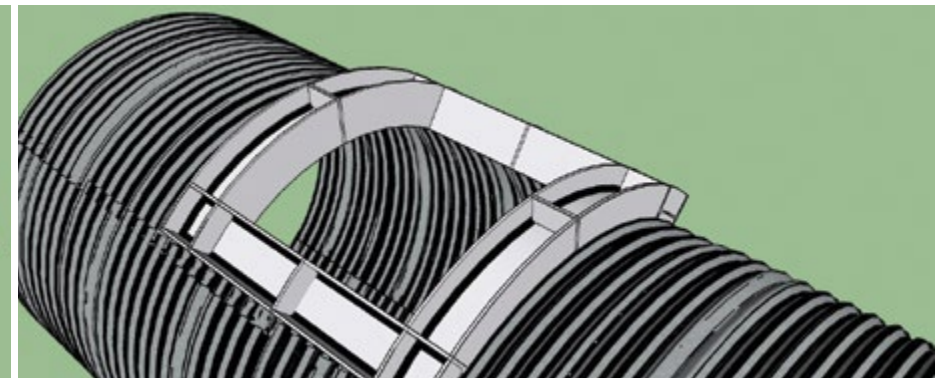

Reinforced Hopper Frame (Mining)

For project assistance call 1-877-245-7473 • Outside Canada +1-778-355-7000

ail.ca

PROUDLY  CANADIAN

Get AIL's innovative engineered solutions working for your better bottom line.

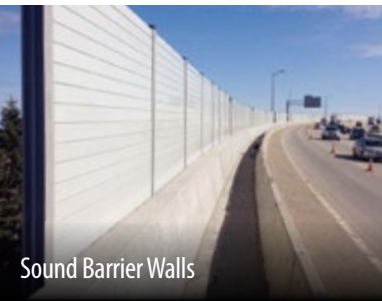
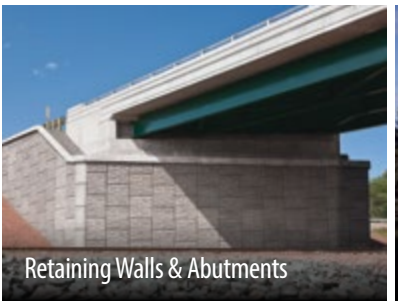
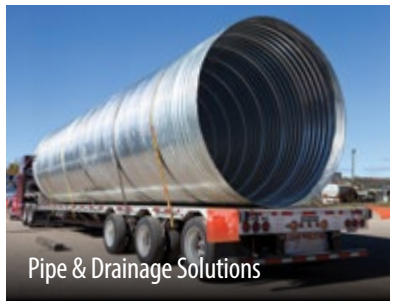
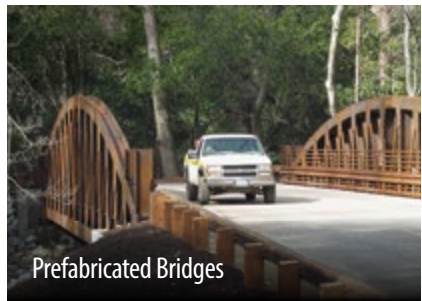

Buried Metal Bridges & Tunnels

Prefabricated Bridges

Modular Panel Bridges

Pipe & Drainage Solutions

Retaining Walls & Abutments

Sound Barrier Walls



Atlantic Industries Limited

Head Office:

PO Box 6161, 32 York St.
Sackville, New Brunswick
Canada E4L 1G6
Phone: (506) 364-4600

Locations across Canada:

St. John's, NL • Deer Lake, NL • Dorchester, NB • Sackville, NB
Louiseville, QC • Ottawa, ON • Toronto, ON • Ayr, ON
Woodstock, ON • Cambridge, ON • Kenora, ON • Calgary, AB
Edmonton, AB • Westlock, AB • Armstrong, BC • Vancouver, BC

The information and suggested applications in this brochure are accurate and correct to the best of our knowledge, and are intended for general information purposes only. These general guidelines are not intended to be relied upon as final specifications, and we do not guarantee specific results for any particular purpose. We strongly recommend consultation with an Atlantic Industries Limited Technical Sales Representative before making any design and purchasing decisions.



AIL products contain recycled content and are 100% recyclable.

Atlantic Industries Limited is a member of
The AIL Group of Companies



Atlantic Industries Limited



INTERNATIONAL



SOUNDWALLS



Illustrations in this brochure are conceptual in nature and are not to be considered technical representations.

©2025 The AIL Group of Companies. Materials contained in this brochure are the property of The AIL Group of Companies. Reproduction in part or in whole without consent is prohibited.

PRINTED IN CANADA AIL-1378 04/2025